

---

**OPERATING INSTRUCTIONS**  
For  
**TRI-PHASE™**  
**True Three-Phase Transformer Turns-Ratio Tester**

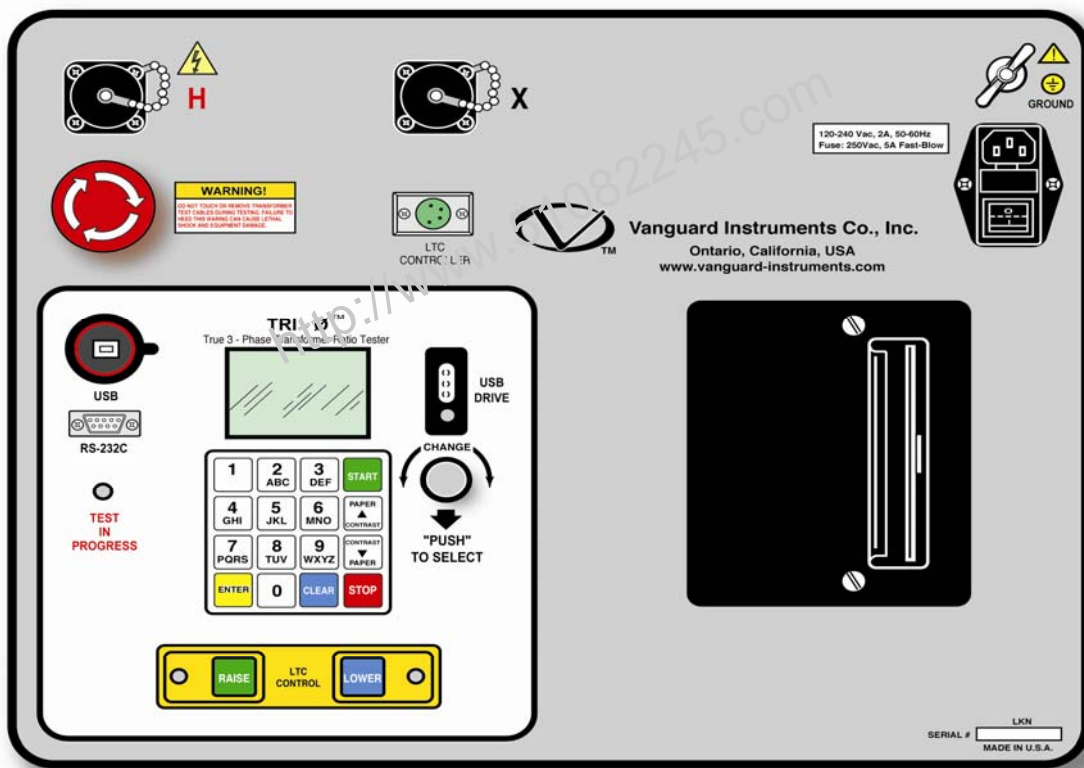

071029TRI648A



Vanguard Instruments Co., Inc.  
1520 S. Hellman Ave.  
Ontario, California 91761, USA

---

TEL: 909-923-9390  
FAX: 909-923-9391

October 2008  
REV. 01

**SAFETY WARNINGS AND CAUTIONS**

Only trained operators shall use this device.

All transformers under test shall be off line and fully isolated.

**Always ground the TRI-PHASE™ to a substation ground before connecting the test cables to a transformer**

**Do Not Modify Test Equipment**

Because of the risk of introducing unknown hazards, do not install substitute parts or perform any unauthorized modifications to any TRI-PHASE™ test device. To ensure that all designed safety features are maintained it is recommended that repairs be performed only by Vanguard Instruments Co. factory personnel or by an authorized repair service. Unauthorized modifications will cause serious safety hazards and will nullify the manufacturer's warranty.

**Follow Exact Operating Procedures**

Any deviation from the procedures described in this operator's manual may create safety hazards, damage the TRI-PHASE™ test device or cause errors in the test results. Vanguard Instruments Co., Inc. assumes no liability for unsafe or improper use of the TRI-PHASE™.

**Table of Contents**

|       |  |    |
|-------|--|----|
| 1.0   | Introduction .....   | 10 |
| 1.1   | Applicability .....  | 10 |
| 2.0   | General Description.....   | 10 |
| 3.0   | Functional Description .....   | 11 |
| 4.0   | Principles of Operation.....   | 12 |
| 5.0   | Specifications .....   | 13 |
| 6.0   | Supplied Cables.....   | 14 |
| 6.1   | Cable Marking and Identification .....                                     | 15 |
| 7.0   | TRI-PHASE™ Front Panel Descriptions.....                                   | 16 |
| 7.1   | TRI-PHASE™ Operating Controls, Indicators and Connectors.....              | 16 |
| 8.0   | TRI-PHASE™ Printer and Printer Paper.....                                  | 18 |
| 9.0   | Memory Storage Capabilities.....   | 18 |
| 9.1   | Test Record Memory Storage Capabilities .....                              | 18 |
| 9.2   | Transformer Test Plan Memory Storage Capabilities.....                     | 18 |
| 10.0  | Operating Voltages.....  | 18 |
| 10.1  | Operating Voltages.....  | 18 |
| 11.0  | Special Features.....  | 19 |
| 11.1  | LCD Contrast Control .....   | 19 |
| 11.2  | Test Voltages.....   | 19 |
| 11.3  | Computer Control And TTRA Software Application.....                        | 19 |
| 11.4  | USB FLASH Memory Thumb Drive .....   | 19 |
| 12.0  | Typical Cable Hook Up Configurations.....                                  | 20 |
| 12.1  | Typical Cable Connections to a Delta-Wye Transformer.....                  | 20 |
| 12.3  | Single Phase Transformer Typical Connections .....                         | 22 |
| 12.4  | Voltage Regulator Typical Connections .....                                | 23 |
| 12.5  | Donut Type (un-mounted) Current Transformer (CT) Typical Connections ..... | 24 |
| 12.6  | Multi-tap CT Typical Connections .....                                     | 25 |
| 12.7  | Bushing-Mount-CT on A Single Phase Transformer Typical Connections .....   | 25 |
| 12.8  | Bushing Mount CT's on Delta Transformer Typical Connections .....          | 26 |
| 12.9  | Bushing Mount CT's on Wye Transformer Typical Connection.....              | 27 |
| 13.0  | Single-Phase Transformer Test Procedure.....                               | 28 |
| 13.1  | Main Menu .....  | 31 |
| 13.2  | Transformer Configuration Selection Menu .....                             | 32 |
| 13.3  | Transformer Name Plate Voltage Menu .....                                  | 33 |
| 13.4  | Transformer Voltage Data Entry Status Displays .....                       | 34 |
| 13.5  | Start/Stop Test Status Display.....  | 35 |
| 13.6  | Test In Progress Status Display.....                                       | 36 |
| 13.7  | Test Results Status Display .....  | 37 |
| 13.8  | Print Test Results Menu .....  | 38 |
| 13.9  | Print Format Menu .....  | 38 |
| 13.10 | Test Result Column Format Printout .....                                   | 40 |
| 13.11 | Test Result Detail Format Printout.....                                    | 41 |
| 13.12 | Keep This Reading Menu.....  | 43 |
| 13.13 | Previous Data In Buf. Menu.....  | 44 |
| 13.14 | Run Another Test Menu.....   | 45 |
| 13.15 | Save This Record Menu .....  | 46 |
| 13.16 | Record Saved Confirmation Status .....                                     | 47 |

|       |   |     |
|-------|---|-----|
| 13.17 | Transformer Name Plate Voltage Menu For Another Test.....       | 48  |
| 13.18 | Test Record Not Saved Menu .....                                | 49  |
| 14.0  | Dyn1 Transformer Test Procedure.....                            | 50  |
| 14.1  | Delta-To-Wye (Dyn) Transformer Test Column Format Printout..... | 53  |
| 14.2  | Delta-To-Wye Transformer Test Detail Format Printout.....       | 55  |
| 15.0  | Auto Detect Transformer Configuration Capability .....          | 58  |
| 16.0  | Test Record Options.....  | 59  |
| 16.1  | Restore A Test Record To Print Procedure.....                   | 59  |
| 16.2  | Setup Menu .....  | 61  |
| 16.3  | Save/Restore Record Menu.....                                   | 62  |
| 16.4  | Restore Record Menu.....  | 63  |
| 16.5  | Restore Record Number Status Display .....                      | 64  |
| 16.6  | Record Restored Menu.....                                       | 65  |
| 16.7  | Print Record To LCD Or Printer Menu.....                        | 66  |
| 16.8  | Print Format Menu .....   | 67  |
| 16.9  | Test Record Printout Column Format .....                        | 68  |
| 16.10 | Test Record Printout Detailed Format.....                       | 69  |
| 16.11 | Save Test Results To A Test Record Procedure .....              | 71  |
| 16.12 | Print Test Record Directory.....                                | 72  |
| 16.13 | Print Directory Menu.....                                       | 73  |
| 16.14 | Record Directory Printout .....                                 | 74  |
| 16.15 | Restore Test Record To LCD Procedure.....                       | 75  |
| 16.16 | Scroll Test Record Menu.....                                    | 77  |
| 16.17 | Restored Record Status Display .....                            | 78  |
| 16.18 | Record Restored Menu.....                                       | 79  |
| 16.19 | Print Record Restored Menu .....                                | 80  |
| 16.20 | Restored Record Status Displays .....                           | 81  |
| 16.21 | Erase A Test Record Procedure .....                             | 82  |
| 16.22 | Erase Record Menu .....   | 83  |
| 16.23 | Erase Record Status Display .....                               | 84  |
| 16.24 | Record Number Erased Confirmation Status Display.....           | 85  |
| 16.25 | Erase All Test Records Procedure.....                           | 86  |
| 16.26 | Erase All Records Status Display.....                           | 87  |
| 16.27 | Record Number Erased Confirmation Status Display.....           | 88  |
| 17.0  | Test Plan Options .....   | 89  |
| 17.1  | Load a Test Plan and Test a Transformer Procedure .....         | 89  |
| 17.2  | Test Plan Menu.....   | 92  |
| 17.3  | Load Test Plan Number Status Display .....                      | 93  |
| 17.4  | Test Plan Loaded Menu.....                                      | 94  |
| 17.5  | Test Plan Loaded Status Display.....                            | 95  |
| 17.6  | Test Plan Test Results Status Display .....                     | 96  |
| 17.7  | Print Test Plan Test Results .....                              | 97  |
| 17.8  | Test Plan Test Results Printout .....                           | 98  |
| 17.9  | Unload a Test Plan Procedure .....                              | 99  |
| 17.10 | Print Test Plan Directory Procedure.....                        | 100 |
| 17.11 | Test Plan Directory Print Out.....                              | 101 |
| 17.12 | Print Test Plan Procedure .....                                 | 102 |
| 17.13 | Print Test Plan Status Display.....                             | 103 |

|       |  |     |
|-------|--|-----|
| 17.14 | Typical Three Phase Dyn1 Test Plan Printout .....                | 104 |
| 17.15 | Erase A Test Plan Procedure .....                                | 105 |
| 17.16 | Erase Test Plan Menu.....  | 106 |
| 17.17 | Erase Test Plan Status Display.....                              | 107 |
| 17.18 | Test Plan Number Erased Confirmation Status Display .....        | 108 |
| 18.0  | Entering Test Record Identification Information Procedure.....   | 109 |
| 19.0  | Test Voltage Selection Procedure .....                           | 111 |
| 19.1  | Test Voltage Selection .....                                     | 112 |
| 20.0  | Test Frequency Selection Procedure .....                         | 113 |
| 20.1  | Test Frequency Selection .....                                   | 114 |
| 21.0  | Change Date And Time Procedure.....                              | 115 |
| 21.1  | Enter Date Status Display .....                                  | 116 |
| 21.2  | Enter Time Status Display.....                                   | 117 |
| 22.0  | H And X Cable Diagnostic Test Procedure.....                     | 118 |
| 23.0  | TRI-PHASE™ Verification Test Procedure .....                     | 119 |
| 24.0  | Load Tap Changer.....  | 120 |
| 25.0  | USB FLASH Thumb Drive.....                                       | 121 |
| 25.1  | Save/Restore Record With Thumb Drive Menu .....                  | 121 |
| 25.2  | Copy Record To Thumb Drive Menu .....                            | 122 |
| 25.3  | Copy Single Record To Thumb Drive Status Displays.....           | 123 |
| 25.4  | Copy All Records To Thumb Drive Status Displays .....            | 124 |
| 25.5  | Test Plan With Thumb Drive Menu .....                            | 125 |
| 25.6  | Copy Test Plan To Thumb Drive Status Display .....               | 126 |
| 25.7  | Test Plan Saved To Thumb Drive Confirmation Status Displays..... | 127 |
| 25.8  | Load Test Plan With Thumb Drive Menu.....                        | 128 |
| 25.9  | Load Thumb Drive Test Plan Status Displays .....                 | 129 |
| 25.10 | Print Test Plan Directory With Thumb Drive Menu.....             | 130 |
| 25.11 | Print Test Plan With Thumb Drive Menu .....                      | 131 |
| 25.12 | Print Thumb Drive Test Plan Status Displays.....                 | 132 |
| 25.13 | Erase Test Plan With Thumb Drive Menu .....                      | 133 |
| 25.14 | Erase Thumb Drive Test Plan Status Displays.....                 | 134 |
| 25.15 | Save Test Plan With Thumb Drive Menu .....                       | 135 |
| 26.0  | Computer Interface Description .....                             | 136 |
| 26.1  | Computer Interface Status Display .....                          | 136 |
| 26.2  | Emergency Turn Off Switch .....                                  | 137 |
| 27.0  | TRI-PHASE™ Firmware Programming Notes.....                       | 138 |

**List of Tables**

|            |   |     |
|------------|---|-----|
| Table 1.0  | TRI-PHASE™ Turns-Ratio Meter Specifications .....                       | 13  |
| Table 2.0  | Supplied Cable Set .....  | 14  |
| Table 3.0  | Cable Markings and Identification .....                                 | 15  |
| Table 4.0  | Model TRI-PHASE™ Front-Panel Controls, Indicators, and Connectors ..... | 17  |
| Table 5.0  | Single-Phase Transformer Test Procedure .....                           | 28  |
| Table 6.0  | Dyn1 Transformer Test Procedure .....                                   | 50  |
| Table 7.0  | Restore A Test Record To Print Procedure .....                          | 59  |
| Table 8.0  | Save Test Results To A Test Record Procedure .....                      | 71  |
| Table 9.0  | Print Test Record Directory Procedure .....                             | 72  |
| Table 10.0 | Restore Test Record To LCD Procedure .....                              | 75  |
| Table 11.0 | Erase A Test Record Procedure .....                                     | 82  |
| Table 12.0 | Erase All Test Records Procedure .....                                  | 86  |
| Table 13.0 | Load a Test Plan and Test a Transformer Procedure .....                 | 89  |
| Table 14.0 | Unload A Test Plan Procedure .....                                      | 99  |
| Table 15.0 | Print Test Plan Directory Procedure .....                               | 100 |
| Table 16.0 | Print Test Plan Procedure .....   | 102 |
| Table 17.0 | Erase A Test Plan Procedure .....                                       | 105 |
| Table 18.0 | Entering Test Record Identification Information Procedure .....         | 109 |
| Table 19.0 | Transformer Test Voltage Selection Procedure .....                      | 111 |
| Table 20.0 | Transformer Test Frequency Selection Procedure .....                    | 113 |
| Table 21.0 | Change Date and Time Procedure .....                                    | 115 |
| Table 22.0 | H And X Cable Diagnostic Test Procedure .....                           | 118 |
| Table 23.0 | TRI-PHASE™ Verification Test Procedure .....                            | 119 |

List of Figures

|             |  |    |
|-------------|--|----|
| Figure 1.0  | Model TRI-PHASE™ Front-Panel Controls, Indicators and Connectors .....     | 16 |
| Figure 2.0  | Typical H & X Cable Connections to a Delta-Wye Transformer .....           | 20 |
| Figure 3.0  | Typical Front Panel Cable Connectors .....                                 | 21 |
| Figure 4.0  | Typical H & X Cable Connections to Delta-Wye Transformer .....             | 21 |
| Figure 5.0  | Single Phase Transformer Typical Connections .....                         | 22 |
| Figure 6.0  | Single Phase Auto Transformer Typical Connections .....                    | 22 |
| Figure 7.0  | Type A Voltage Regulator Typical Connections .....                         | 23 |
| Figure 8.0  | Type B Voltage Regulator Typical Connections.....                          | 23 |
| Figure 9.0  | Donut Type (un-mounted) Current Transformer (CT) Typical Connections ..... | 24 |
| Figure 10.0 | Multi-tap CT Typical Connections.....                                      | 25 |
| Figure 11.0 | Bushing-Mount-CT on A Single Phase Transformer Typical Connections .....   | 25 |
| Figure 12.0 | Bushing Mount CT's on Delta Transformer Typical Connections .....          | 26 |
| Figure 13.0 | Bushing Mount CT's on Wye Transformer Typical Connection .....             | 27 |
| Figure 14.0 | Main Menu .....  | 31 |
| Figure 15.0 | Transformer Configuration Selection First Menu .....                       | 32 |
| Figure 16.0 | Transformer Configuration Selection Second Menu.....                       | 32 |
| Figure 17.0 | Transformer Nameplate Voltage Menu.....                                    | 33 |
| Figure 18.0 | Name Plate Voltage Status Display .....                                    | 34 |
| Figure 19.0 | Name Plate Voltage Display, H Voltage Keyed In .....                       | 34 |
| Figure 20.0 | Name Plate Voltage Display, H Voltage Entered.....                         | 34 |
| Figure 21.0 | Name Plate Voltage Display, X Voltage Keyed In .....                       | 34 |
| Figure 22.0 | Start/Stop Test Status Display .....                                       | 35 |
| Figure 23.0 | Test In Progress Status Display .....                                      | 36 |
| Figure 24.0 | Test Results Status Display .....  | 37 |
| Figure 25.0 | Print Test Results Menu .....  | 38 |
| Figure 26.0 | Print Format Menu .....  | 38 |
| Figure 27.0 | Single Phase Column Format Printout .....                                  | 40 |
| Figure 28.0 | Single Phase Detail Format Printout .....                                  | 41 |
| Figure 29.0 | Keep This Reading Menu .....   | 43 |
| Figure 30.0 | Previous Data In Buf Menu.....   | 44 |
| Figure 31.0 | Run Another Test Menu .....  | 45 |
| Figure 32.0 | Save This Record Menu .....  | 46 |
| Figure 33.0 | Record Saved Confirmation Status Display .....                             | 47 |
| Figure 34.0 | Nameplate Voltage Selection Menu For Another Test.....                     | 48 |
| Figure 35.0 | Test Record Not Saved Menu.....  | 49 |
| Figure 36.0 | Dyn1 Column Format Printout.....   | 53 |
| Figure 37.0 | Dyn1 Detail Format Printout .....  | 55 |
| Figure 38.0 | Setup Menu.....  | 61 |
| Figure 39.0 | Save/Restore Record Menu .....   | 62 |
| Figure 40.0 | Restore Record Menu .....  | 63 |
| Figure 41.0 | Restore Record Number Status Display .....                                 | 64 |
| Figure 42.0 | Record Restored Menu .....   | 65 |
| Figure 43.0 | Print Record Menu .....  | 66 |
| Figure 44.0 | Print Format Menu .....  | 67 |
| Figure 45.0 | Test Record Printout Column Format .....                                   | 68 |
| Figure 46.0 | Test Record Printout Detailed Format.....                                  | 69 |
| Figure 47.0 | Print Directory Menu.....  | 73 |
| Figure 48.0 | Record Directory Printout .....  | 74 |
| Figure 49.0 | Scroll Test Record Menu.....   | 77 |
| Figure 50.0 | Restored Record Status Display .....                                       | 78 |
| Figure 51.0 | Record Restored Menu .....   | 79 |

|              |   |     |
|--------------|---|-----|
| Figure 52.0  | Print Record Restored Menu .....                                  | 80  |
| Figure 53.0  | Restored Record First Status Display .....                        | 81  |
| Figure 54.0  | Restored Record Second Status Display .....                       | 81  |
| Figure 55.0  | Erase Record Menu .....   | 83  |
| Figure 56.0  | Erase Record Status Display .....                                 | 84  |
| Figure 57.0  | Record Number Erased Status Display .....                         | 85  |
| Figure 58.0  | Erase All Records Status Display .....                            | 87  |
| Figure 59.0  | Records Erased Status Display .....                               | 88  |
| Figure 60.0  | Test Plan Menu.....   | 92  |
| Figure 61.0  | Load Test Plan Number Status Display.....                         | 93  |
| Figure 62.0  | Test Plan Loaded Menu.....  | 94  |
| Figure 63.0  | Test Plan Loaded Status Display .....                             | 95  |
| Figure 64.0  | Test Plan Test Results Status Display .....                       | 96  |
| Figure 65.0  | Test Plan Test Results Printout Column Format .....               | 98  |
| Figure 66.0  | Test Plan Directory Print Out.....                                | 101 |
| Figure 67.0  | Print Test Plan Status Display .....                              | 103 |
| Figure 68.0  | Typical Three Phase Dyn1 Test Plan Printout.....                  | 104 |
| Figure 69.0  | Erase Test Plan Menu.....   | 106 |
| Figure 70.0  | Erase Test Plan Status Display .....                              | 107 |
| Figure 71.0  | Test Plan Number Erased Status Display .....                      | 108 |
| Figure 72.0  | Test Voltage Selection Menu .....                                 | 112 |
| Figure 73.0  | Test Frequency Selection Menu .....                               | 114 |
| Figure 74.0  | Enter Date Status Display.....                                    | 116 |
| Figure 75.0  | Enter Time Status Display.....                                    | 117 |
| Figure 76.0  | Load Tap Changer Controller.....                                  | 120 |
| Figure 77.0  | Save/Restore Record With Thumb Drive Menu.....                    | 121 |
| Figure 78.0  | Copy Record To Thumb Drive Menu.....                              | 122 |
| Figure 79.0  | Copy Single Record To Thumb Drive Status Displays.....            | 123 |
| Figure 80.0  | Copy All Records To Thumb Drive Status Displays .....             | 124 |
| Figure 81.0  | Test Plan With Thumb Drive Menu .....                             | 125 |
| Figure 82.0  | Copy Test Plan To Thumb Drive Status Display .....                | 126 |
| Figure 83.0  | Test Plan Saved To Thumb Drive Confirmation Status Displays ..... | 127 |
| Figure 84.0  | Load Test Plan Number With Thumb Drive Menu .....                 | 128 |
| Figure 85.0  | Load Thumb Drive Test Plan Status Displays.....                   | 129 |
| Figure 86.0  | Print Test Plan Directory With Thumb Drive Menu .....             | 130 |
| Figure 87.0  | Print Test Plan With Thumb Drive Menu .....                       | 131 |
| Figure 88.0  | Print Thumb Drive Test Plan Status Displays.....                  | 132 |
| Figure 89.0  | Erase Test Plan With Thumb Drive Menu .....                       | 133 |
| Figure 90.0  | Erase Thumb Drive Test Plan Status Displays.....                  | 134 |
| Figure 91.0  | Save Test Plan With Thumb Drive Menu .....                        | 135 |
| Figure 92.0  | Computer Interface Status Display.....                            | 136 |
| Figure 93.0  | Computer Interface Status Display.....                            | 137 |
| Figure 94.0  | Firmware Revision Menu 1 .....                                    | 138 |
| Figure 95.0  | Firmware Revision Menu 2 .....                                    | 139 |
| Figure 96.0  | Firmware Revision Menu 3 .....                                    | 139 |
| Figure 97.0  | Firmware Revision Menu 3 .....                                    | 139 |
| Figure 98.0  | Firmware Revision Menu 4 .....                                    | 140 |
| Figure 99.0  | Firmware Revision Menu 5 .....                                    | 140 |
| Figure 100.0 | Firmware Revision Menu 6.....                                     | 140 |



**List of Appendices**

APPENDIX A ..... 141  
APPENDIX B ..... 142

<http://www.51082245.com>

## **1.0 Introduction**

### **1.1 Applicability**

This manual is applicable to the True Three-Phase Transformer Turns-Ratio (TRI-PHASE™) Tester model made by Vanguard Instruments Company, Inc.

### **2.0 General Description**

The TRI-PHASE™ is a true three-phase, field-portable, automatic transformer turns-ratio test instrument designed to conform to IEEE C57.12.90 measurement method. The TRI-PHASE™ is designed for on-site measurement of turns-ratios, winding polarity, phase angles, and no-load excitation currents of single phase and three-phase utility transformers, potential transformers (PT's), and primary current transformers (CT's)

Since the TRI-PHASE™ is capable of outputting a **true three-phase excitation test voltage** (for testing three-phase transformers), it can easily measure turns-ratios and phase angles of Zig-Zag, T type, special configuration, and phase shifting transformers.

A built-in Load Tap Changer (LTC) controller provides the capability to raise or lower the LTC tap position from the TRI-PHASE™ front panel.

The TRI-PHASE™ can be controlled from the front panel keypad (Stand Alone Mode) or in Computer Control Mode with an IBM compatible Personal Computer (PC) via the Universal Serial Bus (USB) port or RS-232C port.

The TRI-PHASE™ is supplied with single phase and three-phase hook-up cables, LTC control cables, an RS232 serial cable, a USB cable, and a *Microsoft Windows™* based PC Transformer Turns Ratio Analyzer (TTRA) software application.

The TTRA software is provided on a compact disk along with the unit. New released TTRA software and TRI-PHASE™ firmware are available to all users on the Vanguard Instruments web site ([www.vanguard-instruments.com](http://www.vanguard-instruments.com)).

### 3.0 Functional Description

The TRI-PHASE™ measures a transformer turns-ratio from its windings by applying a 3-phase test voltage across the primary (H) winding and sensing the induced voltage on the secondary (X) winding. The measured voltage ratio between H and X is virtually the same as the turns-ratio of the windings because of no load on the windings during testing. The TRI-PHASE™ is capable of testing either single phase or three phase transformers. The need to change test leads to test each phase on three phase transformers is eliminated using the three-phase cables. The TRI-PHASE™ will automatically test each phase of the transformer. The TRI-PHASE™ also has the following features:

- Capable of testing with 3 test voltages; 8Vac, 40Vac, and 100Vac.
- Capable of testing three-phase transformers in Delta, Wye, Zig-Zag, and T type configurations.
- Capable of displaying transformer phase angle relationships between primary and secondary windings.
- Capable of automatically detecting and testing 130 three-phase transformer types defined by ANSI, CEI/IEC and Australian standards. Refer to appendix B for the different transformer configurations.
- Capable of testing phase-shifting transformer turns-ratios and displaying phase shift angles.
- Capable of performing test cable hook-up error checks before each test and automatically aborting the test when there is an error.
- Capable of calculating the transformer turns-ratio based on the operator data entry of the transformer nameplate voltages.
- Capable of calculating the percentage error based on the difference between the calculated and measured turns-ratio values.
- Capable of saving transformer test result(s) in the on-board FLASH EEPROM. The test result data consists of H and X nameplate voltages, phase A/B/C turns-ratios, excitation current and phase angle measurements.
- Capable of storing a total of 112 test records in the on-board FLASH EEPROM. A test record may contain up to 33 tests. Stored test records may be recalled, printed or transferred to an IBM compatible PC with the built-in RS-232C port or USB interface port.
- Capable of storing up to 128 test plans in the on-board FLASH EEPROM. A test plan provides the capability to store transformer nameplate voltages.
- Capable of printing “PASS” or “FAIL” test results of each of the transformer tests.
- Capable of storing test records and transformer test plans to an external FLASH memory drive via the built-in USB FLASH memory thumb drive interface.
- Capable of printing test reports with a built-in 4.5-inch wide thermal printer.
- Capable of alpha-numeric input with the 16-key, alpha-numeric keypad.
- Capable of menu and submenu selection with either the alpha-numeric input or with a rotary switch knob control.
- Capable of displaying data entry, menus, test results, and status readouts with the Liquid Crystal Display (LCD) 64 by 128 dot graphic, back-lighted, sunlight readable display.
- Users can retrieve test records, review test records, and create test plans. Under computer control operation with the supplied Transformer Turns-Ratio Analyzer (TTRA) software application, the TTRA software application allows the user to perform a transformer turns ratio test and saves the test results directly to a compatible IBM PC. The test data is stored in ASCII format for database compatibility.

### 3.0 Functional Description (continued)

- The TTRA software application is compatible with *Microsoft Windows XP*, and *Microsoft Windows Vista* (see section 11.3 for more details).
- Capable of raising or lowering the Load Tap Changer (LTC) tap position from the TRI-PHASE™ front panel with the built-in LTC controller (see section 24.0 for more details).

### 4.0 Principles of Operation

The TRI-PHASE™ measures transformer turns-ratios (using the ANSI/IEEE C57.12.90 method) by applying a test voltage across the primary (H) winding and sensing the induced voltage on the secondary (X) side. For safety, testing is always done in a step-down transfer, regardless of the transformer's actual use. Since there is no load on the windings during testing, the measured voltage ratio is virtually the same as the winding turns-ratio.

The TRI-PHASE™ checks for test cable hook-up errors before each test. It applies a low-level test voltage (300 mV) across the winding being tested and senses the induced secondary voltage. If the induced voltage is greater than the applied excitation voltage, a hookup error is assumed. If a connection error is detected, the TRI-PHASE™ aborts the test and displays "Hook-Up Error" on the LCD. If no hookup error is detected, the TRI-PHASE™ applies a full test voltage to the transformer winding being tested and the turns-ratio (or voltage ratio) is displayed on the LCD.

The winding polarity and phase-angle are determined by comparing the induced voltage waveform to the test voltage waveform (which is used as the reference). In-phase waveforms (+) measure a phase angle centered about 0 degrees. Out-of-phase waveforms (–) measure a phase angle centered about 180 degrees.

The TRI-PHASE™ measures turns-ratios in the range from 0.8 to 15,000. Excitation current (flowing in the H leads) is measured for reference and ranges from 0 to 2,000mA. Winding polarity is displayed as a "+" or "–" sign in front of the measured ratio. The phase angle is measured in degrees with a resolution of  $\pm 0.2$  degrees.

**NOTE:**

*The phase angle measurement is not displayed on the LCD.  
The phase angle measurement will be printed when the detail print format is selected  
and displayed with a PC running the TTRA software application.*

**5.0 Specifications**

TRI-PHASE™ specifications are listed in Table 1.0.

**Table 1.0 TRI-PHASE™ Turns-Ratio Meter Specifications**

|                                    |  |
|------------------------------------|--|
| Type                               | Portable, True Three-Phase Transformer Turns-Ratio Meter   |
| Size                               | 17" (43.2cm) L by 21" (53.3cm) W by 9" (22.9cm) H  |
| Weight                             | 35lbs/15.9Kg   |
| Input Voltage                      | 3 A, 100-240Vac 50/60Hz  |
| Turns-ratio Measuring Ranges       | 0.8-999: ±0.1%, 1,000-1,599: ±0.2%, 1,600-9,999: ±1% @ 8Vac<br>10,000-15,000: ±1.5% @ 8Vac<br>0.8-999: ±0.1%, 1,000-1,599: ±0.2%, 1,600-9,999: ±1% @ 40Vac<br>10,000-15,000: ±1.5% @ 40Vac<br>0.8-999: ±0.1%, 1,000-1,599: ±0.2%, 1,600-9,999: ±1% @ 100Vac<br>10,000-15,000: ±1.5% @ 100Vac |
| Excitation Voltages                | Three-phase, 8Vac, 40Vac, 100Vac (Selectable)  |
| Excitation Current                 | 1A @ 8Vac, 0.2A @ 40Vac, 0.1A @ 100Vac   |
| Current Reading Range              | 0 to 2,000mA   |
| Current Reading Accuracy           | ±0.1mA, ±2% of reading (±1mA)  |
| Phase Angle Reading                | 0 to 360 degrees   |
| Phase Angle Reading Accuracy       | ±0.2 degrees of Reading (±1 Digit)   |
| Winding Polarity                   | Displayed on LCD screen  |
| Display                            | Back-lit LCD screen, 64 x 128 dot graphic display, Viewable in sun light   |
| Computer Interface                 | One RS-232C port and one USB port  |
| FLASH Memory Thumb Drive Interface | One USB FLASH memory thumb drive interface port  |
| Memory Storage Capabilities        | Store 112 test records. A test record may contain up to 99 test results.<br>Store 128 test plans. A test plan may contain up to 33 tests.  |
| LTC Contacts Rating                | 240Vac, 2A   |
| Temperature                        | Operating: -10°C to 55°C (15°F to 122°F)<br>Storage: -30°C to 70°C (-22°F to 158°F)  |
| Warranty                           | One Year on Parts and Labor  |

**NOTE:**

*All Specifications herein are valid at nominal voltage and ambient temperature of +25° C (+77° F).  
Specifications are subject to change without notice.*

6.0 Supplied Cables

**Table 2.0 Supplied Cable Set**

| Item | Description                                    | Qty |
|------|--|-----|
| 1    | H Test-Lead Cable, 15-foot Single-Phase Cables | 1   |
| 2    | X Test-Lead Cable, 15-foot Single-Phase Cables | 1   |
| 3    | H Test-Lead Cable, 15-foot Three-Phase Cables  | 1   |
| 4    | X Test-Lead Cable, 15-foot Three-Phase Cables  | 1   |
| 5    | H Extension Cable, 20-foot Three-Phase Cables  | 1   |
| 6    | X Extension Cable, 20-foot Three-Phase Cables  | 1   |
| 7    | LTC Control Cable, 15-foot                     | 1   |
| 8    | RS-232C Cable                                  | 1   |
| 9    | USB Cable                                      | 1   |
| 9    | Power cord                                     | 1   |
| 10   | Ground Cable                                   | 1   |

**NOTE:**

*A canvas cable-carrying bag is included with the cable set.*

**6.1 Cable Marking and Identification**

Both the H and X cable test leads are terminated with heavy-duty battery clips. Test cable leads are identified as follows.

**Table 3.0 Cable Markings and Identification**

| <b>Test Cable Name</b> | <b>Transformer Terminals</b> | <b>Clip Color</b> | <b>Identification</b> |
|------------------------|------------------------------|-------------------|-----------------------|
| Single Phase H Cables  | H1                           | Red               | H1/1U/A               |
| Single Phase H Cables  | H2                           | Red               | H2/1V/B               |
| Single Phase X Cables  | X1                           | Black             | X1/2U/a               |
| Single Phase X Cables  | X2                           | Black             | X2/2V/b               |
| Three Phase H Cables   | H0                           | Red               | H0/1N/n               |
| Three Phase H Cables   | H1                           | Red               | H1/1U/A               |
| Three Phase H Cables   | H2                           | Red               | H2/1V/B               |
| Three Phase H Cables   | H3                           | Red               | H3/1W/C               |
| Three Phase X Cables   | X0                           | Black             | X0/2N/n               |
| Three Phase X Cables   | X1                           | Black             | X1/2U/a               |
| Three Phase X Cables   | X2                           | Black             | X2/2V/b               |
| Three Phase X Cables   | X3                           | Black             | X3/2W/c               |
| LTC Cable              | RAISE (two connections)      | Green             | RAISE                 |
| LTC Cable              | LOWER (two connections)      | White             | LOWER                 |

7.0 TRI-PHASE™ Front Panel Descriptions

7.1 TRI-PHASE™ Operating Controls, Indicators and Connectors

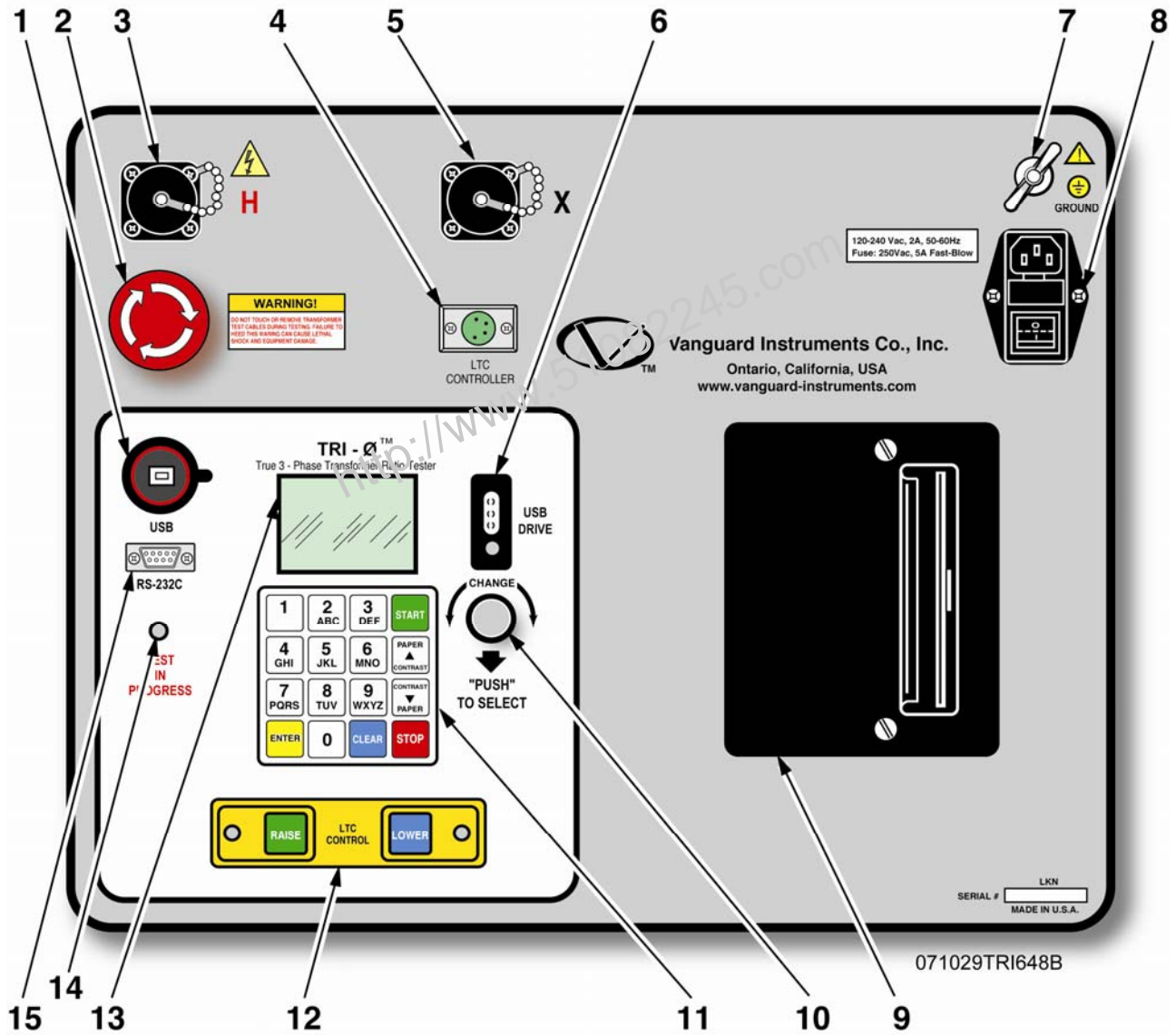

Figure 1.0 Model TRI-PHASE™ Front-Panel Controls, Indicators and Connectors



7.1 TRI-PHASE™ Operating Controls, Indicators and Connectors (continued)

Table 4.0 Model TRI-PHASE™ Front-Panel Controls, Indicators, and Connectors

| Fig. 2.0 Index | Panel Markings  | Functional Description   |     |        |   |    |   |    |   |     |
|----------------|---|--|-----|--------|---|----|---|----|---|-----|
| 1              | <b>USB</b>  | USB interface port to PC   |     |        |   |    |   |    |   |     |
| 2              | <b>EMERGENCY<br/>TURN OFF<br/>“PUSH”</b>                                  | Emergency turn off test voltage switch   |     |        |   |    |   |    |   |     |
| 3              | <b>H</b>  | H voltage test connector   |     |        |   |    |   |    |   |     |
| 4              | <b>LTC<br/>CONTROLLER</b>   | Load Tap Changer controller connector  |     |        |   |    |   |    |   |     |
| 5              | <b>X</b>  | X voltage test connector   |     |        |   |    |   |    |   |     |
| 6              | <b>USB DRIVE</b>  | USB FLASH memory thumb drive interface port  |     |        |   |    |   |    |   |     |
| 7              | <b>None (wing nut)</b>  | Ground stud connected to substation ground   |     |        |   |    |   |    |   |     |
| 8              | <b>120-240Vac, 2 A,<br/>50/ 60Hz<br/>Fuse: 250Vac, 5 A,<br/>Fast Blow</b> | Input power connector and fused power switch with third-wire safety ground   |     |        |   |    |   |    |   |     |
| 9              | <b>None (printer)</b>   | Thermal printer, 4.5-inch wide printout  |     |        |   |    |   |    |   |     |
| 10             | <b>CHANGE<br/>“PUSH”<br/>TO SELECT</b>                                    | Control Knob: <i>Turning this Control Knob scrolls through different menu options</i> (shown on LCD). <i>Select the displayed menu option by pushing the knob.</i>   |     |        |   |    |   |    |   |     |
| 11             | <b>None (keypad)</b>  | pushbutton operating controls, 16-keys   |     |        |   |    |   |    |   |     |
| 12             | <b>LTC CONTROL</b>  | Load Tap Changer Control push button switches  |     |        |   |    |   |    |   |     |
| 13             | <b>None (LCD display)</b>   | LCD display 64 by 128 dot graphic, back-lighted, sunlight readable display   |     |        |   |    |   |    |   |     |
| 14             | <b>TEST IN PROGRESS</b>   | This red LED flashes in response to a command or when a test voltage is applied to the test transformer. The red LED flashes with a corresponding beeping sound at a 1 second rate during test.  |     |        |   |    |   |    |   |     |
| 15             | <b>RS-232C</b>  | RS-232C connector for interface to an IBM compatible computer. A 9-pin, female DB type connector. Data rate is set to 115,000 baud, 1 start bit, 8 data bits, 2 stop bits, and no parity bit. Connector pin functions are:<br><table style="margin-left: 40px;"> <tr> <td>PIN</td> <td>SIGNAL</td> </tr> <tr> <td>2</td> <td>Rx</td> </tr> <tr> <td>3</td> <td>Tx</td> </tr> <tr> <td>5</td> <td>Gnd</td> </tr> </table> | PIN | SIGNAL | 2 | Rx | 3 | Tx | 5 | Gnd |
| PIN            | SIGNAL  |  |     |        |   |    |   |    |   |     |
| 2              | Rx  |  |     |        |   |    |   |    |   |     |
| 3              | Tx  |  |     |        |   |    |   |    |   |     |
| 5              | Gnd   |  |     |        |   |    |   |    |   |     |

## **8.0 TRI-PHASE™ Printer and Printer Paper**

The TRI-PHASE™ built-in thermal printer uses 4.5-inch wide thermal paper for printing test results. In order to maintain the highest quality printing and to avoid paper jams we recommend using the paper supplied by our factory. Paper can be ordered from the following sources.

Vanguard Instruments Co, Inc.  
1520 S. Hellman Ave.  
Ontario, CA 91761  
Tel: 909-923-9390  
Fax: 909-923-9391  
Part Number: TP-4 Paper

OR

BG Instrument Co.  
13607 E. Trent Ave.  
Spokane, WA 99216  
Tel: 888-244-4004  
Fax: 509-893-9803  
Part Number: TP4 paper

## **9.0 Memory Storage Capabilities**

### **9.1 Test Record Memory Storage Capabilities**

The TRI-PHASE™ is capable of storing up to 112 transformer test records in the on-board FLASH EEPROM. The TRI-PHASE™ is capable of restoring test records from the on-board FLASH EEPROM. After a test record is restored it may be viewed on the TRI-PHASE™ LCD screen and/or transferred to a USB FLASH memory thumb drive, to a PC, or printed using the built-in thermal printer. Storing more than 112 transformer test records requires a USB FLASH memory thumb drive. A USB FLASH thumb drive is capable of storing 999 transformer test records.

### **9.2 Transformer Test Plan Memory Storage Capabilities**

Each TRI-PHASE™ is capable of storing up to 128 Transformer Test Plans in the FLASH EEPROM. Test plans allow the operator to perform a complete transformer test and obtain PASS/FAIL results.

## **10.0 Operating Voltages**

### **10.1 Operating Voltages**

The TRI-PHASE™ operating voltage is 100-240Vac, 50/60Hz.

The TRI-PHASE™ has built-in ground fault isolation detection and will only operate with operating voltages that are ground-fault isolated.

## **11.0 Special Features**

### **11.1 LCD Contrast Control**

To darken the LCD display, press and hold the “▲ Contrast” switch for more than two seconds. To lighten the LCD display, press and hold the “▼ Contrast” switch for more than two seconds.

### **11.2 Test Voltages**

The TRI-PHASE™ has three selectable test voltages: 8Vac, 40Vac, and 100Vac. The TRI-PHASE™ has two selectable test frequencies, 50 Hz and 60 Hz. Refer to Table 19.0 for test voltage selection.

### **11.3 Computer Control And TTRA Software Application**

The TRI-PHASE™ may be controlled by an IBM compatible PC via the RS-232 interface port or USB interface port. Cables for the RS-232C and USB connections are supplied with each TRI-PHASE™. The operator connects the appropriate PC interface cable to the TRI-PHASE™. A *Microsoft Windows™* Based PC TTRA software application is delivered with each TRI-PHASE™. The TRI-PHASE™ test result data is stored in ASCII format making it possible to export the data into any database desired. *Microsoft Windows XP™*, and *Microsoft Windows Vista™* support the TTRA software application. Using this software application, the operator has the ability to:

- Perform transformer test(s) under control of the PC
- Save transformer test results directly to the PC
- Transfer test records stored in the TRI-PHASE™ FLASH EEPROM to the PC
- Transfer transformer test plans generated by the TTRA to the TRI-PHASE™ FLASH EEPROM memory
- Transfer test records from the TRI-PHASE™ FLASH EEPROM to the thumb drive
- Transfer test plans generated by the TTRA into the thumb drive

### **11.4 USB FLASH Memory Thumb Drive**

The USB FLASH memory thumb drive is capable of storing test records and test plans. This device will be referred to from now on as the “thumb drive”. Many of the operational menus described in this manual will contain an extra option to select the thumb drive. When this option is selected, the submenus will allow for selection of the internal FLASH EEPROM memory or the thumb drive FLASH memory. Refer to section 25.0 for further details of the menus which have this option.

## 12.0 Typical Cable Hook Up Configurations

Always ground the TRI-PHASE™ with the provided ground cable contained in the cable set before connecting H and X cables. Ground the transformer bushings before connecting test leads to transformer. This procedure prevents inducing any voltages into the TRI-PHASE™. All transformer buss connections must be removed and transformer isolated before performing testing of transformer. Typical TRI-PHASE™ cable connections to different transformers are illustrated in Figure 2.0 to Figure 13.0.

### 12.1 Typical Cable Connections to a Delta-Wye Transformer

Typical cable connections to a Delta to Wye transformer are shown in Figure 2.0 and Figure 4.0.

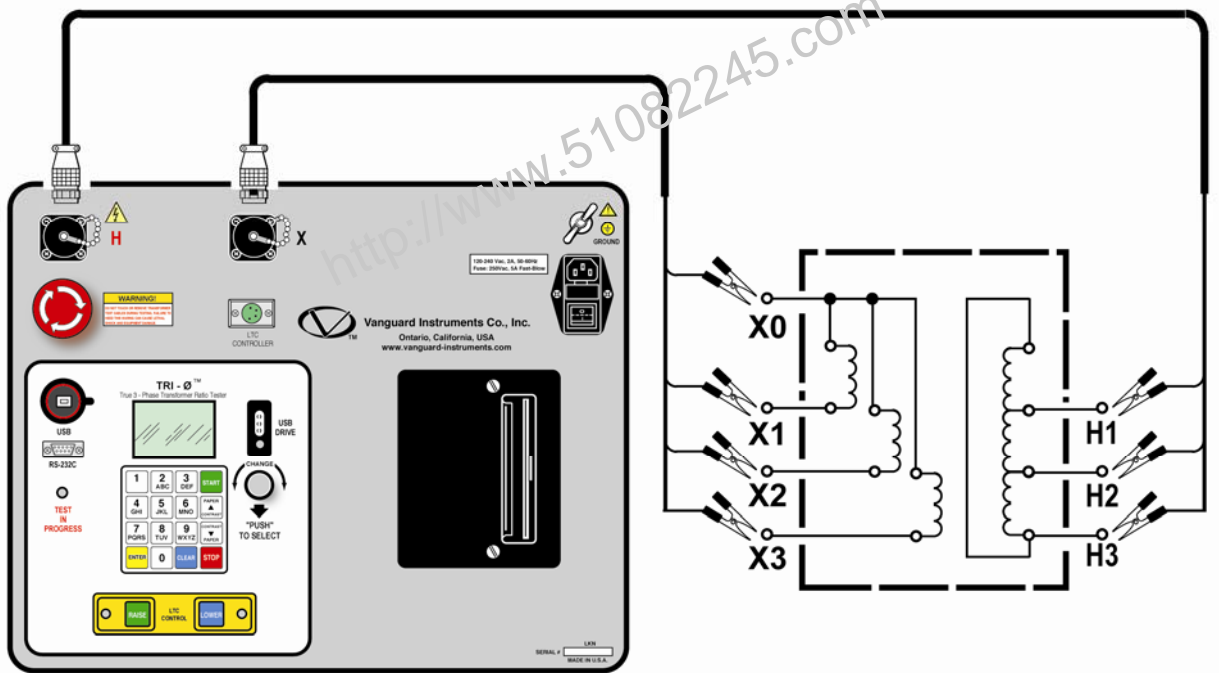

Figure 2.0 Typical H & X Cable Connections to a Delta-Wye Transformer

12.2 Typical Cable Connections to a Delta-Wye Transformer (continued)



Figure 3.0 Typical Front Panel Cable Connectors

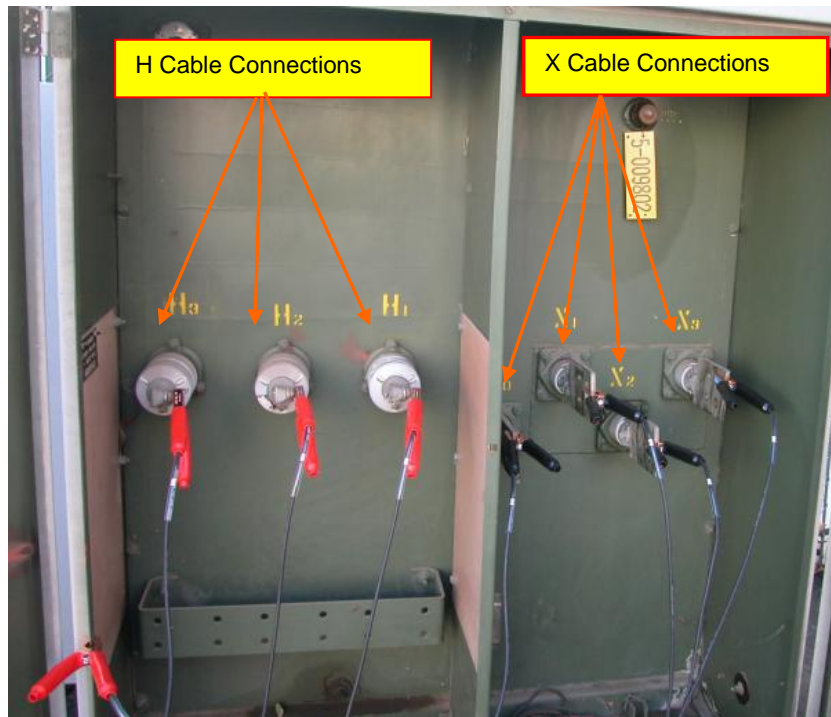

Figure 4.0 Typical H & X Cable Connections to Delta-Wye Transformer

12.3 Single Phase Transformer Typical Connections

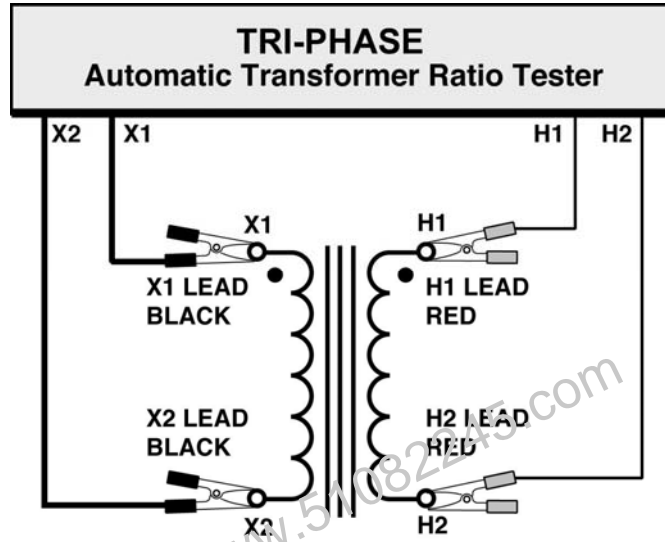

Figure 5.0 Single Phase Transformer Typical Connections

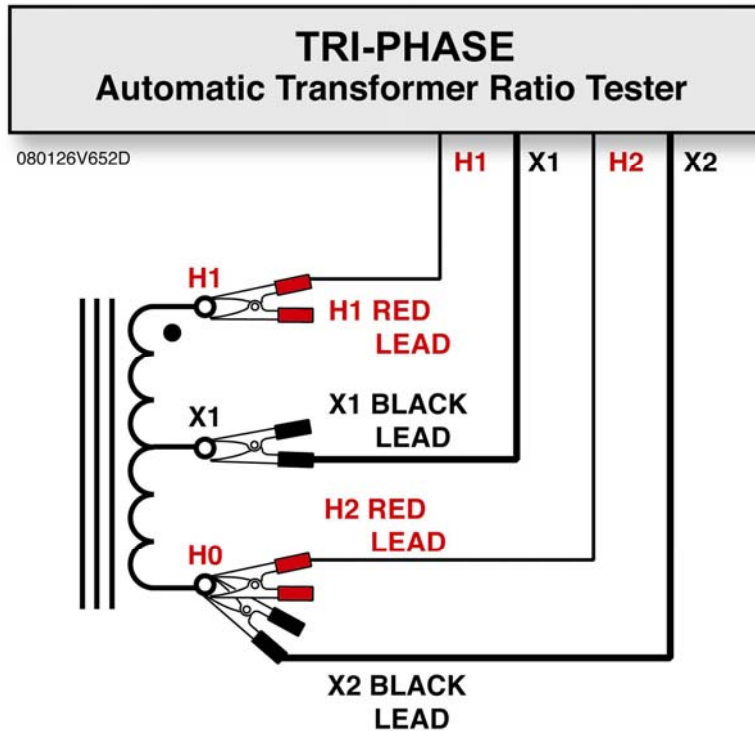

Figure 6.0 Single Phase Auto Transformer Typical Connections

12.4 Voltage Regulator Typical Connections

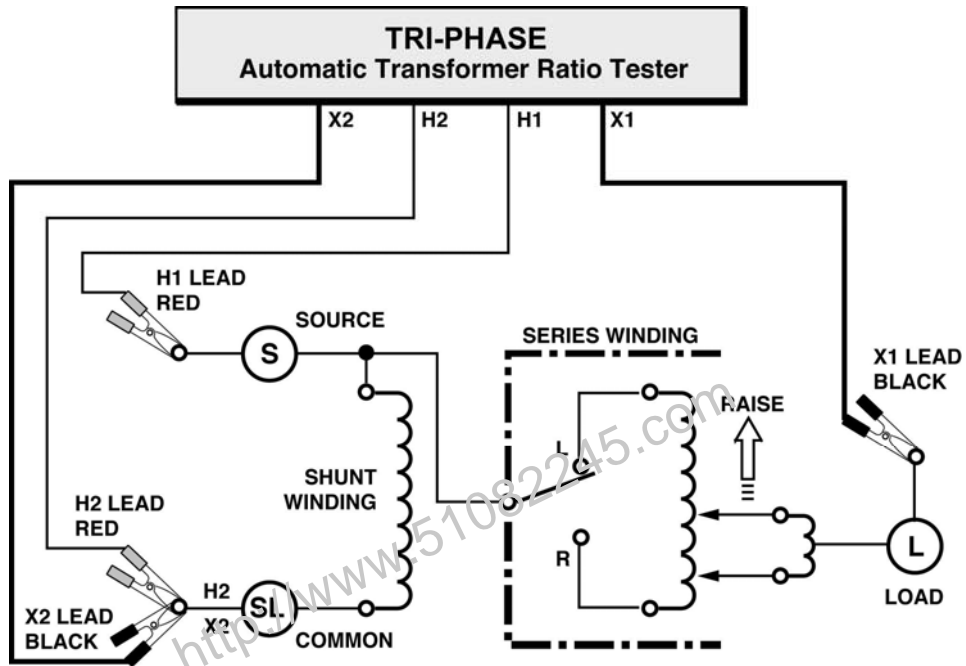
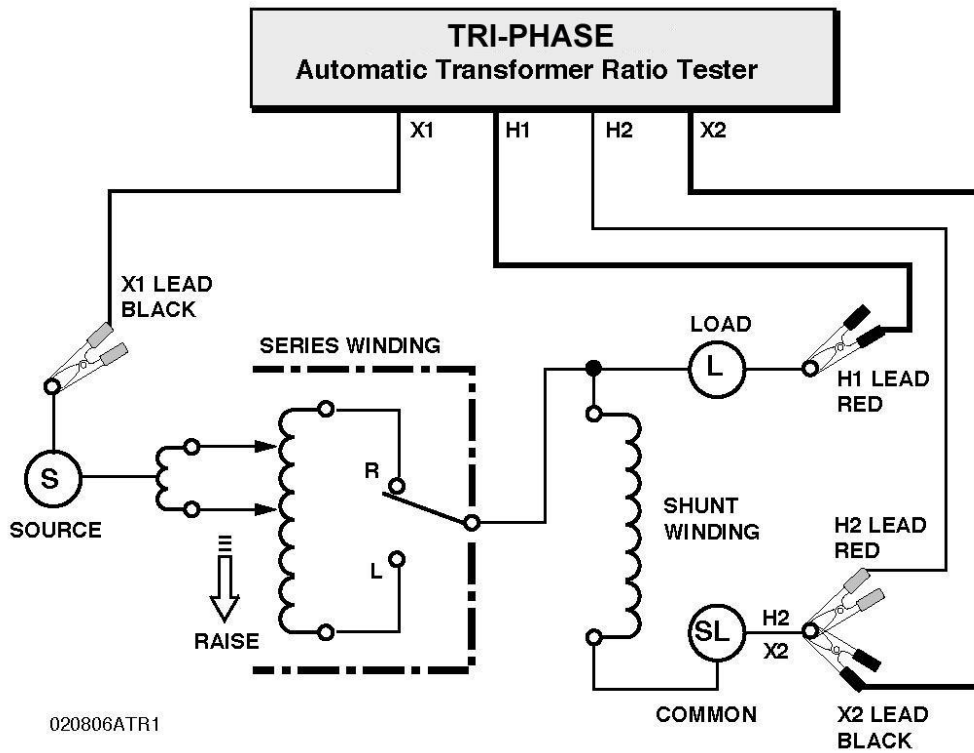

Figure 7.0 Type A Voltage Regulator Typical Connections



020806ATR1

Figure 8.0 Type B Voltage Regulator Typical Connections

12.5 Donut Type (un-mounted) Current Transformer (CT) Typical Connections

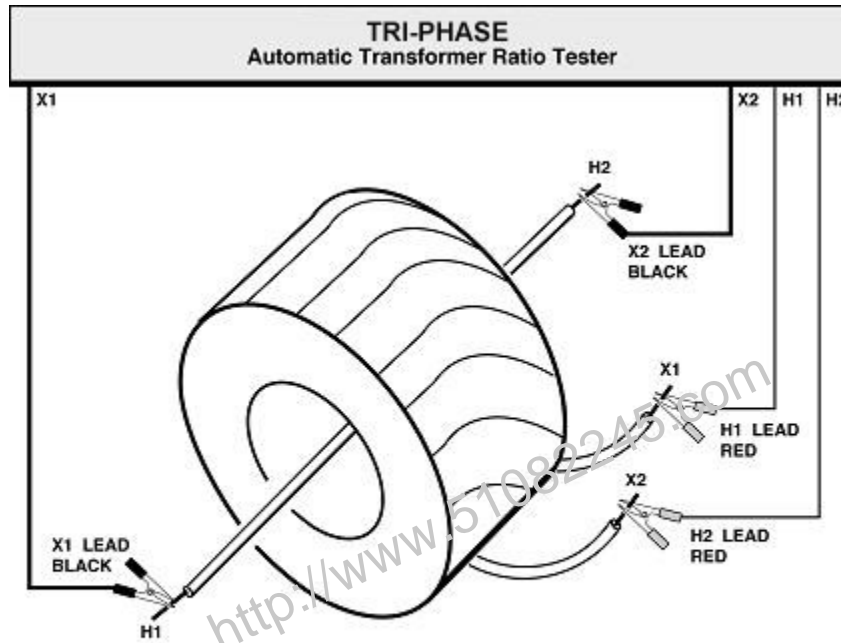

Figure 9.0 Donut Type (un-mounted) Current Transformer (CT) Typical Connections

**NOTE:**

*H and X test leads are reversed for the CT ratio test shown above.*



12.6 Multi-tap CT Typical Connections

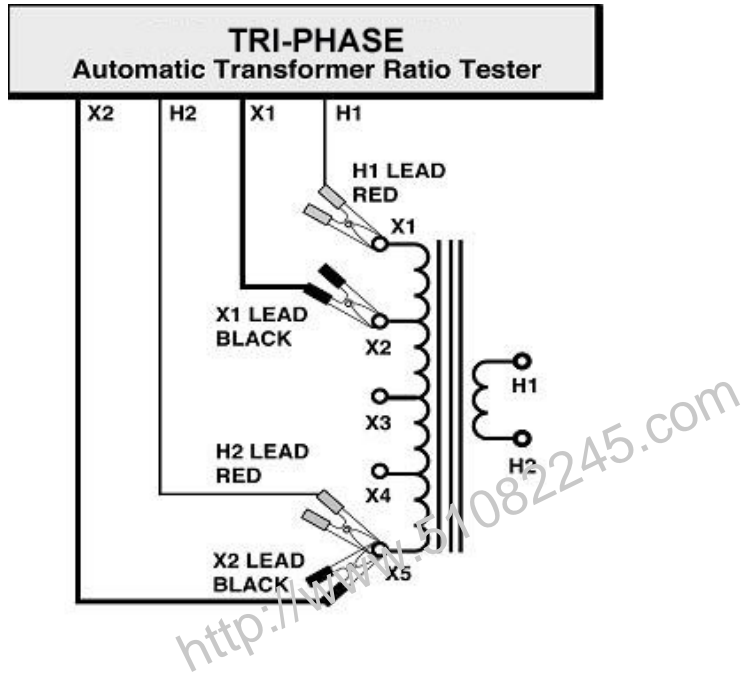

Figure 10.0 Multi-tap CT Typical Connections

12.7 Bushing-Mount-CT on A Typical Single Phase Transformer Connections

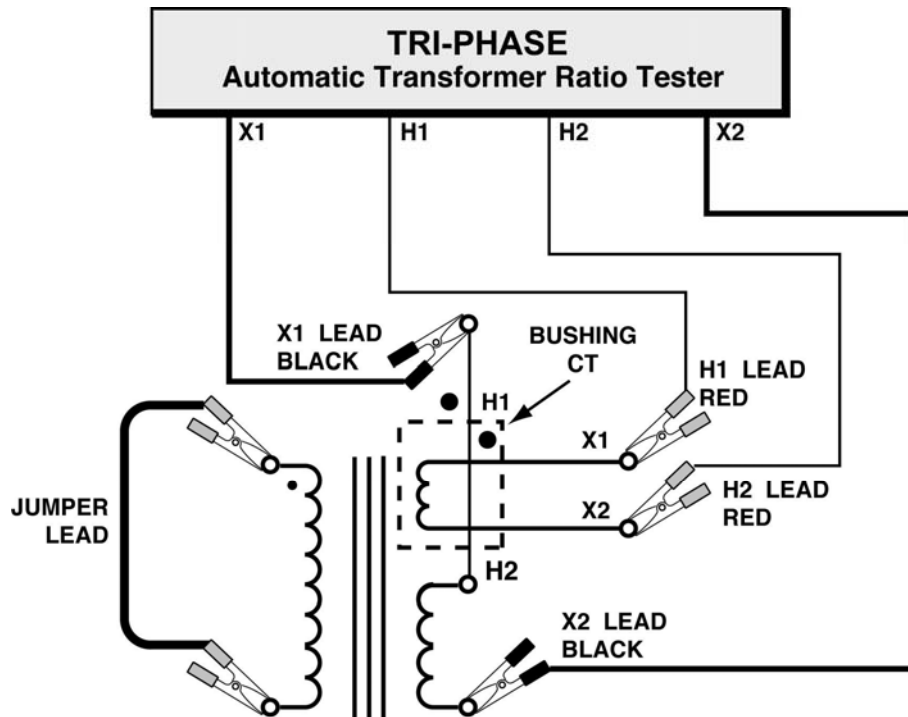

Figure 11.0 Bushing-Mount-CT on A Typical Single Phase Transformer Connections

12.8 Bushing Mount CT's on Typical Delta Transformer Connections

**NOTE:**

*Install jumper on the unused winding*

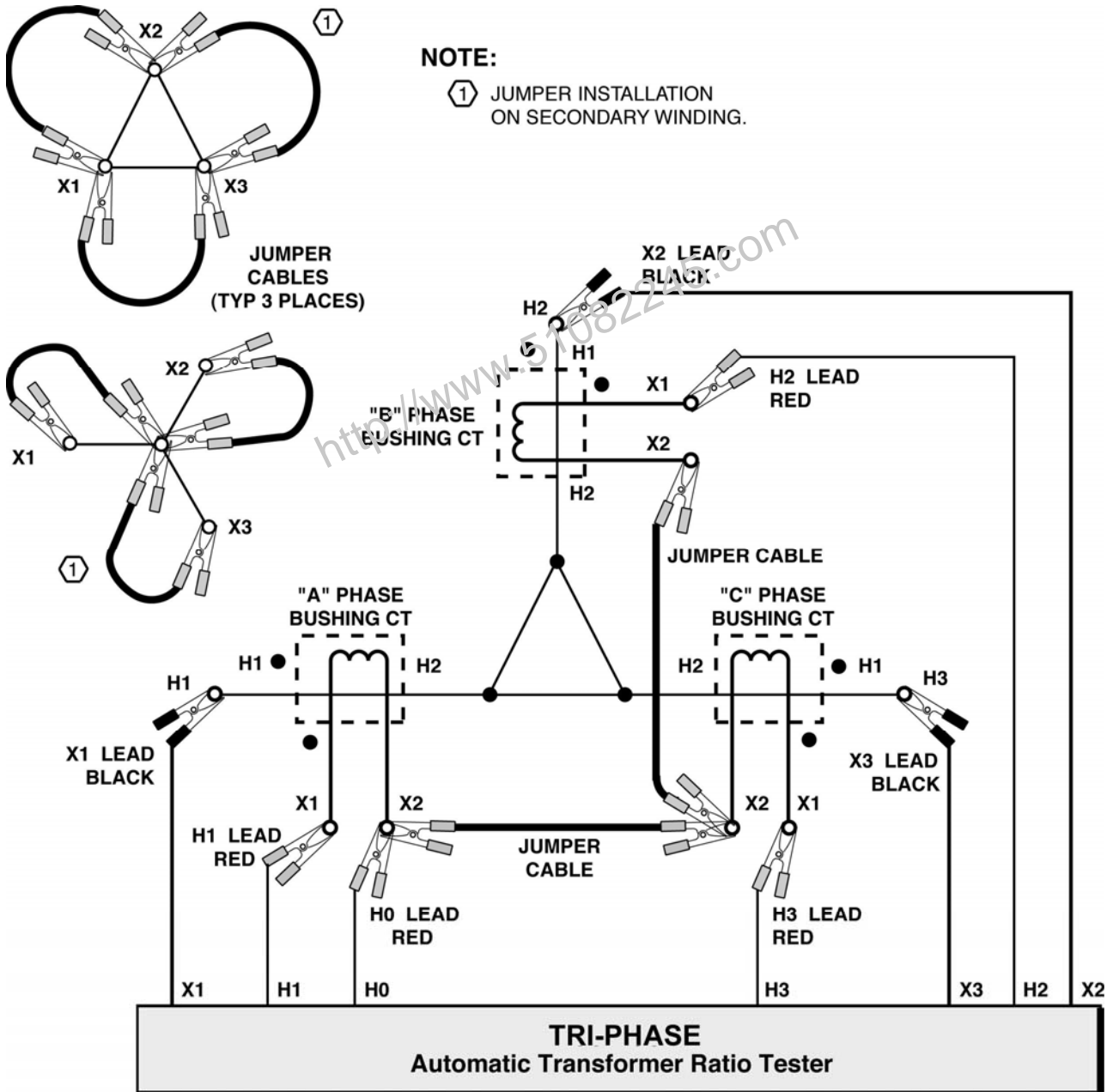

Figure 12.0 Bushing Mount CT's on Typical Delta Transformer Connections

**NOTE:**

*The CT turns-ratio is obtained by performing a YNd test.  
Install jumpers on transformer secondary windings.*

12.9 Bushing Mount CT's on Typical Wye Transformer Connection

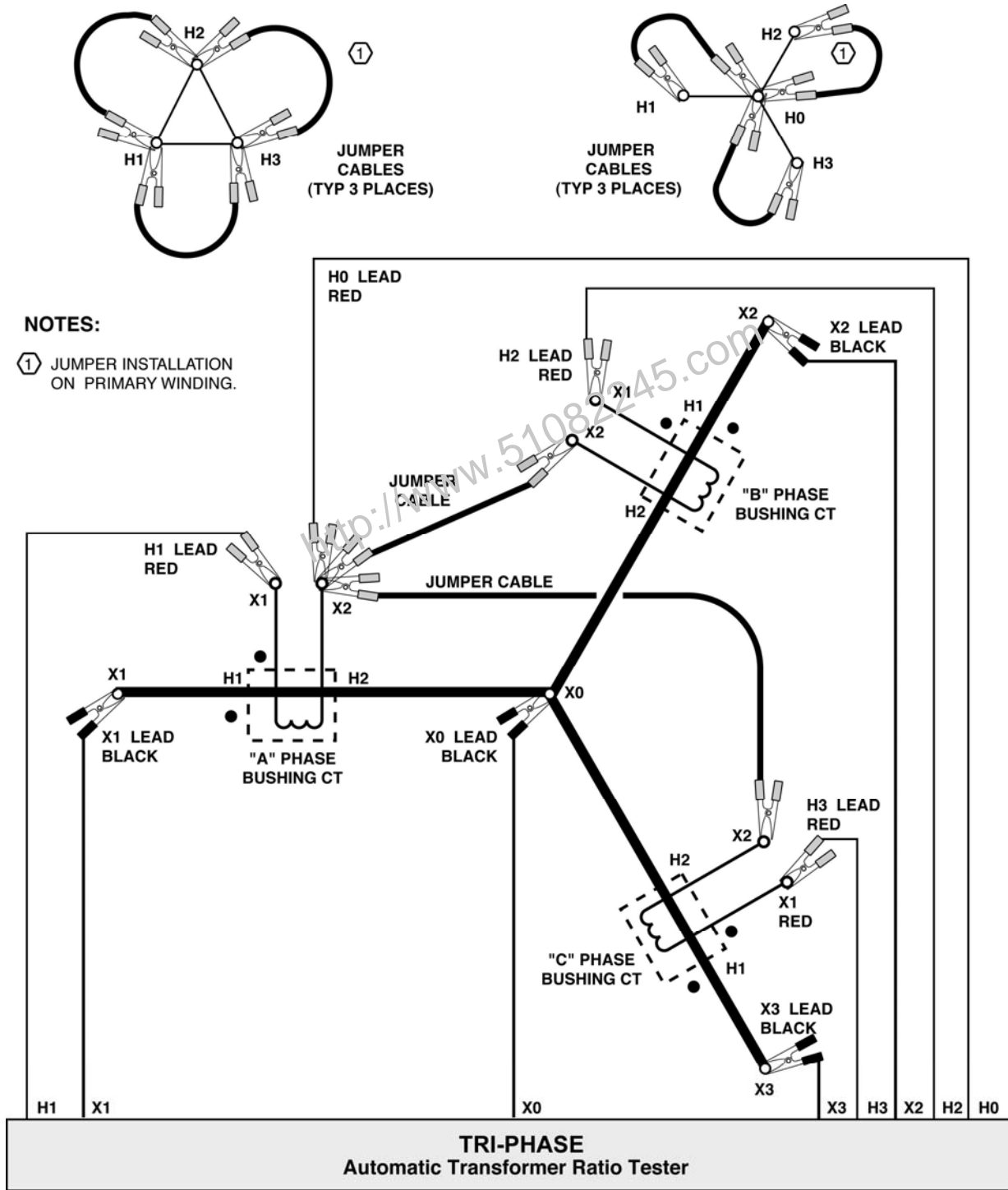

Figure 13.0 Bushing Mount CT's on Typical Wye Transformer Connection

**NOTE:**

The CT turns-ratio is obtained by performing an YNyn test.  
 Install jumpers on transformer primary windings.

**13.0 Single-Phase Transformer Test Procedure**

Table 7.0 shows the procedure to test a single-phase transformer (2,400 V/240 V). Detailed descriptions of each menu are provided in the following sub-sections. Refer to Figure 1.0 for location of controls. The precondition for the following test procedure is that no previous single-phase transformer test has been performed (i.e., no stored test results in non-volatile memory), and there were no previous test records restored to non-volatile memory.

**NOTE:**

*Pressing the “STOP” button aborts all tests and/or submenus and returns the LCD screen display to the “Main Menu”.*

**Table 5.0 Single-Phase Transformer Test Procedure**

| STEP | DESCRIPTION  | DISPLAY   | ACTION  |
|------|--|---|---|
| 1    | Select “Run Test” from the “Main Menu”   | <b>1.RUN TEST</b><br>2.SETUP<br>3.TEST PLAN<br>4.DIAGNOSTIC<br>TIME: 20:15:00<br>DATE: 07/16/08 | Press key number 1 or push down Control Knob                              |
| 2    | Select “Single Phase” from “Transformer Configuration Menu”                            | <b>XFMR CONFIG:</b><br><b>1.SINGLE PHASE</b><br>2.Dy<br>3.Yd<br>4.Dd<br>5.Yy<br>6.Next Page     | Press key number 1 or push down Control Knob                              |
| 3    | “Transformer Name Plate Voltage Status Display”<br>Select “YES”                        | <b>XFMR NAME PLATE VLTG</b><br><b>1.YES</b><br>2.NO   | Press key number 1 or push down Control Knob                              |
| 4    | “Name Plate Voltage Status Display”<br>Enter H line voltage from transformer nameplate | <b>NAME PLATE VOLTAGE:</b><br>H : X<br>0 :  | Use keys 0-9 for data entry of transformer name plate voltage             |
| 5    | “Name Plate Voltage Status Display”<br>Confirm H voltage                               | <b>NAME PLATE VOLTAGE:</b><br>H : X<br>2,400 :  | Press “ENTER” or push down Control Knob<br>(2400 was keyed for this test) |
| 6    | “Name Plate Voltage Status Display”<br>Enter X line voltage from transformer nameplate | <b>NAME PLATE VOLTAGE:</b><br>H : X<br>2,400: 0   | Use key numbers 0-9 for data entry  |
| 7    | “Name Plate Voltage Status Display”<br>Confirm X voltage                               | <b>NAME PLATE VOLTAGE:</b><br>H : X<br>2,400 : 240  | Press “ENTER” or push down Control Knob<br>(240 was keyed for this test)  |

13.0 Single-Phase Transformer Test Procedure (continued)

Table 5.0 Single-Phase Transformer Test Procedure (continued)

| STEP | DESCRIPTION  | DISPLAY  | ACTION   |
|------|--|--|--|
| 8    | “Start/Stop Test Status Display”   | “START” TO TEST<br>OR<br>“STOP” TO ABORT                   | Press START key  |
| 9    | “Test in Progress” status display  | TEST IN PROGRESS<br>PLEASE WAIT...                         | None   |
| 10   | “Test Results Status Display”<br>Observe ratio, excitation current, and percentage error on LCD display  | RATIO      mA      %DIFF<br>+10.005    1.9      0.05       | None   |
| 11   | “Test Results Status Display”<br>Go to next LCD display  | RATIO      mA      %DIFF<br>+10.005    1.9      0.05       | Press any key or push down Control Knob  |
| 12   | Select “YES” from the “Print Test Results Menu” to print test result on built-in printer   | PRINT TEST RESULTS?<br>1.YES<br>2.NO                       | Press key number 1 or push down Control Knob   |
| 13   | Select “Column” from the “Print Format Menu”   | PRINT FORMAT<br>1.COLUMN<br>2.DETAILED                     | Press key number 1 or push down Control Knob for a column report.  |
| 14   | Select “YES” from the “Keep This Reading Menu” to store current test reading (i.e., test results) in non-volatile memory<br>NOTE:<br>Refer to note at end of table | KEEP THIS READING?<br>1.YES<br>2.NO                        | Press key number 1 or push down Control Knob to store reading  |
| 15   | “Test Saved Status Display”<br>Current test reading is saved   | TEST SAVED   | Press any key or push down Control Knob  |
| 16   | Select “NO” from the “Run Another Test Menu”   | RUN ANOTHER TEST?<br>1.YES<br>2.NO<br>3. REPEAT PREV. TEST | Press key number 2<br>Selection of 2 may be made by turning the Control Knob. Push down Control Knob after 2 is selected |
| 17   | Selecting “YES” from the “Save This Record Menu”<br>Store test results in FLASH EEPROM   | SAVE THIS RECORD?<br>1.YES<br>2.NO                         | Press key number 1 or push down Control Knob   |

13.0 Single-Phase Transformer Test Procedure (continued)

Table 5.0 Single-Phase Transformer Test Procedure (continued)

| STEP | DESCRIPTION  | DISPLAY  | ACTION                                  |
|------|--|--|---|
| 18   | “Record Saved” confirmation status display<br>Test results saved in FLASH EEPROM as a test record<br>NOTE:<br>The next sequential record number (#) is automatically generated and displayed | <b>RECORD NUMBER #<br/>HAS BEEN SAVED</b>  | Press any Key or push down Control Knob |
| 19   | Return to “Main Menu”  | <b>1.RUN TEST</b><br><b>2.SETUP</b><br><b>3.TEST PLAN</b><br><b>4.DIAGNOSTIC</b><br><b>TIME: 20:15:00</b><br><b>DATE: 07/16/08</b> | None                                    |

**NOTE:**

The precondition for the above test procedure was that no previous single-phase transformer test record was residing in temporary memory. Once a single phase test record has been saved to FLASH EEPROM, or a single phase test record restored from FLASH EEPROM and another single phase transformer test is performed, selecting “YES” in response to “Keep This Reading” at step 17 results by displaying the following menu.

|                                     |
|-------------------------------------|
| <p><b>PREVIOUS DATA IN BUF.</b></p> |
| <p><b>1.APPEND PREV. DATA</b></p>   |
| <p><b>2.CLEAR PREV. DATA</b></p>    |

Selecting menu option 1 (“Append Prev. Data”) will result in appending the current test results to all of the previous test results from the test record stored in temporary memory, assigning this new record to the next test record number in sequence. Selecting menu option 2, “Clear Prev. Data” will result in clearing the temporary memory of all previous test results from the test record except the current test results and assigning this test result to the next sequential test record number. The temporary memory will be lost when the TRI-PHASE™ is powered-off, but the test records remain in the TRI-PHASE™ FLASH EEPROM non-volatile internal memory.

13.1 Main Menu

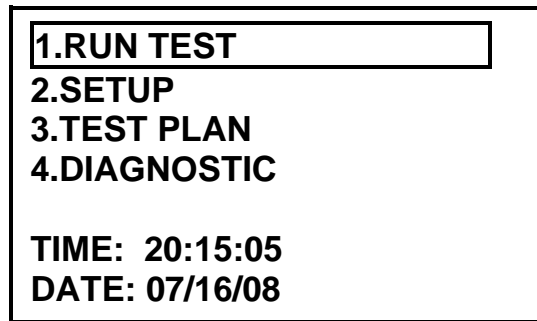

Figure 14.0 Main Menu

- a. **Description:** The “Main Menu” (i.e., “start-up”) provides selection of the primary functions of the TRI-PHASE™. These functions consist of one or more sub-menus that allow the operator to test a transformer, select various settings or options, select test plan options, or perform diagnostics on the TRI-PHASE™.
- b. **Origin:** The “Main Menu” displays on the LCD after power is applied to the TRI-PHASE™.
- c. **Action Options:**
  - Press key number 1 to select “Run Test”
  - Press key number 2 to select “Setup”
  - Press key number 3 to select “Test Plan Menu”
  - Press key number 4 to select “Diagnostic”
  - Selection may also be made by turning the Control Knob to select a menu option and then pushing down on the Control Knob once the selection is made.
- d. **Action To Perform:** Select menu option 1 for this example.

**NOTES:**

*Real time and date is displayed at the bottom of LCD screen.  
Refer to section 11.1 for LCD contrast control operation.*

To return to the “Main Menu” at any time press “STOP” on the keypad.

13.2 Transformer Configuration Selection Menu

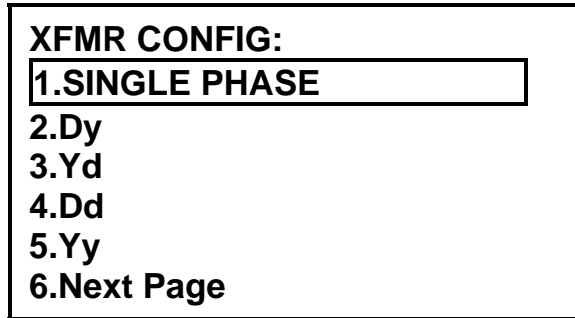

Figure 15.0 Transformer Configuration Selection First Menu

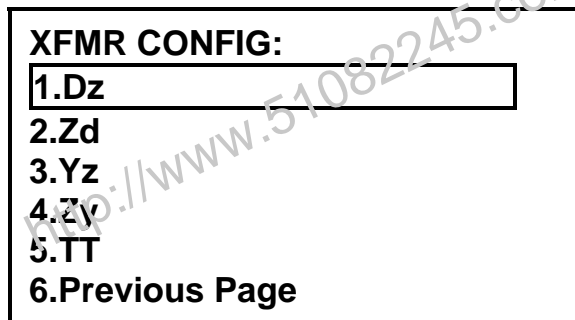

Figure 16.0 Transformer Configuration Selection Second Menu

- a. **Description:** Either “Transformer Configuration Selection Menu” above will allow the operator to select the transformer type to be tested. There are two menus for this selection. The first menu is shown in Figure 15.0 which is displayed first. When the operator selects “Next Page” from the first menu, the second menu is displayed as shown in Figure 16.0.
- b. **Origin:** The “Transformer Configuration Selection” first menu displays after selecting “Run Test” from the “Main Menu” (Figure 14.0).
- c. **Action Options:** Select the type of transformer configuration to be tested by pressing key numbers that correspond to the numbered menu items on the keypad, or by turning the Control Knob to the desired menu item, then pushing down on the Control Knob once selected.
- d. **Action To Perform:** With the first menu displayed, select the menu option 1 for this example.

**NOTE:**

*The TRI-PHASE™ will support 130 transformer types defined by ASNCI/CEI/ICE standards. All transformer configurations supported by the TRI-PHASE™ are listed in Appendix B.*



13.3 Transformer Name Plate Voltage Menu



Figure 17.0 Transformer Nameplate Voltage Menu

- a. **Description:** This menu provides access to the “Name Plate Voltage” status display (Figure 18.0) for entry of the transformer nameplate voltages which are used to derive a calculated turns-ratio. The calculated turns-ratio is then used to compare the measured turns-ratio and calculate a percentage error reading.
- b. **Origin:** The transformer nameplate voltage menu displays after selecting “Single Phase” from options listed in the “Transformer Configuration Selection Menu” (Figure 15.0). For other transformer configurations, this menu displays prior to the “Start/Stop Test” status display.
- c. **Action Options:** Press key number 1 (“YES”) push down the Control Knob to use the calculated turns-ratio in the test results and advance to the “Name Plate Voltage” status display (Figure 18.0). Press key number 2 to bypass this option and advance to the “Start/Stop Test” status display (Figure 22.0). Selection may also be made by turning the Control Knob to select a menu option, then pushing down on the Control Knob once the selection is made.
- d. **Action To Perform:** Select menu option 1 for this example.

13.4 Transformer Voltage Data Entry Status Displays

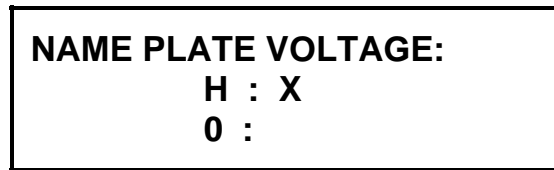

Figure 18.0 Name Plate Voltage Status Display

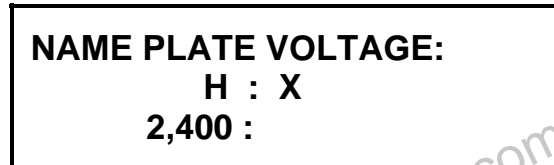

Figure 19.0 Name Plate Voltage Display, H Voltage Keyed In

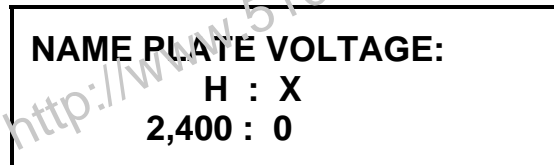

Figure 20.0 Name Plate Voltage Display, H Voltage Entered

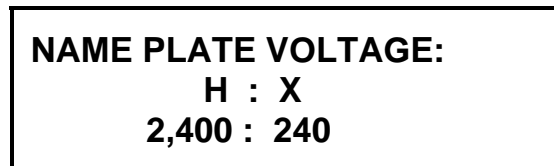

Figure 21.0 Name Plate Voltage Display, X Voltage Keyed In

- a. **Description:** Allows for entry of the H and X voltages for the transformer to be tested, which are used to calculate the turns-ratio. The operator enters the transformer nameplate voltages.
- b. **Origin:** The name plate voltage status will display on LCD after the operator has selected menu option 1 on the “Transformer Name Plate Voltage Menu” (Figure 17.0).
- c. **Action Options:** Press key numbers 0 thru 9 to enter transformer voltages. Press the “ENTER” key to confirm voltage entry. The Control Knob may be pushed down after the numeric keys are pressed for each entry of H and X voltages. Press the “CLEAR” key to re-enter data.
- d. **Action To Perform:** Enter name plate voltages of 2400 for H, and enter 240 for X for this test example.

### 13.5 Start/Stop Test Status Display



**Figure 22.0 Start/Stop Test Status Display**

- a. Description:** Allows the operator to start to test or abort a test.
- b. Origin:** The LCD displays “Start/Stop Test Status Display” after the operator enters the nameplate voltage for X (Figure 21.0) or selects 2 on the “Transformer Name Plate Voltage Menu” (Figure 17.0).
- c. Action Options:** Press the “START” key to start a test and advance to the “Test In Progress Status Display” (Figure 23.0). Press the “STOP” key to abort a test and return to the “Main Menu”.
- d. Action To Perform:** Press the “START” key to start the test for this example.

### 13.6 Test In Progress Status Display



**Figure 23.0 Test In Progress Status Display**

- a. **Description:** The “Test In Progress Status Display” (Figure 23.0) is displayed when the turns-ratio test is performed.
- b. **Origin:** The LCD displays the “Test In Progress Status Display” after the operator presses the “START” key (Figure 22.0).
- c. **Action Options:** None.
- d. **Action To Perform:** Observe status.

13.7 Test Results Status Display

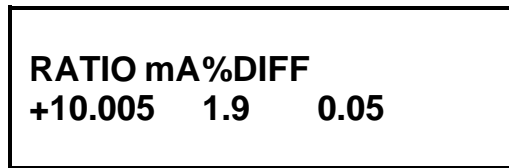

**Figure 24.0 Test Results Status Display**

- a. Description:** Displays the transformer winding polarity, turns-ratio, excitation current (in milliamps), and turns-ratio percentage error after completion of the transformer test. A typical turns-ratio test result screen is shown in Figure 24.0. The display result is explained below:

Ratio displayed: 10.005  
 Polarity displayed: “+” (in phase)  
 Excitation current: 1.9 mA  
 Percentage error: 0.05%

- b. Origin:** The LCD displays “Test Results Status Display” (Figure 24.0) after the “Test In Progress Status Display” (Figure 23.0).
- c. Action Options:** Press any key or push down the Control Knob to go to the “Print Test Results Menu” (Figure 25.0).
- d. Action To Perform:** Observe the test result status, then press any key or push down the Control Knob.

**NOTE:**

“% DIFF” is calculated as the Absolute Value of  $[(Cal\ ratio - Measured\ ratio)/Cal\ ratio] \times 100$ .  
 “% DIFF” will only be displayed if nameplate voltages were entered.

### 13.8 Print Test Results Menu

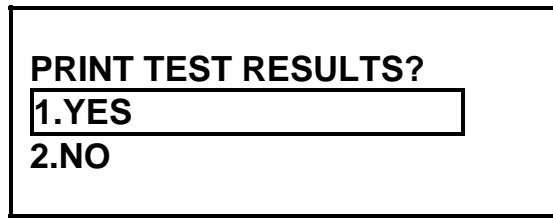

**Figure 25.0 Print Test Results Menu**

- a. **Description:** The TRI-PHASE™ has the capability to print the current test results (displayed on the LCD screen) using the built-in thermal printer.
- b. **Origin:** The “Print Test Results Menu” is displayed after operator presses any key or pushes down on the Control Knob from the “Test Result Status Display” (Figure 24.0).
- c. **Action Options:** Press key number 1 (“YES”) or push down the Control Knob to advance to the “Print Format Menu” (Figure 26.0). Press key number 2 to advance to “Keep This Reading Menu” (Figure 29.0). Number 2 may be selected by turning the Control Knob, then pushing down on the Control Knob after 2 is selected.
- d. **Action To Perform:** Select menu option 1 for this example.

### 13.9 Print Format Menu

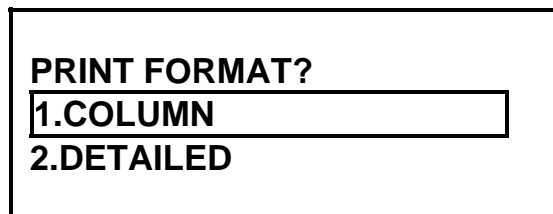

**Figure 26.0 Print Format Menu**

- a. **Description:** Allows the operator to select which format to use for printing the test results. Refer to Figure 27.0 for a typical column format printout. Refer to Figure 28.0 for a detailed format printout.
- b. **Origin:** This menu is displayed after the operator selects 1 (“YES”) from the “Print Test Results Menu” (Figure 25.0).
- c. **Action Options:** Press key number 1 or push down on the Control Knob to select the column format print out of the test results. Press key number 2 to select the detail format printout of the test results. Number 2 may be selected by turning the Control Knob, then

pushing down on the Control Knob after number 2 is selected.

- d. **Action To Perform:** Select menu option 1 for this example.
- e. **Results of Action:** Once the desired print format is selected the test results are printed and the LCD displays the “Keep This Reading Menu” (Figure 29.0).

<http://www.51082245.com>

13.10 Test Result Column Format Printout

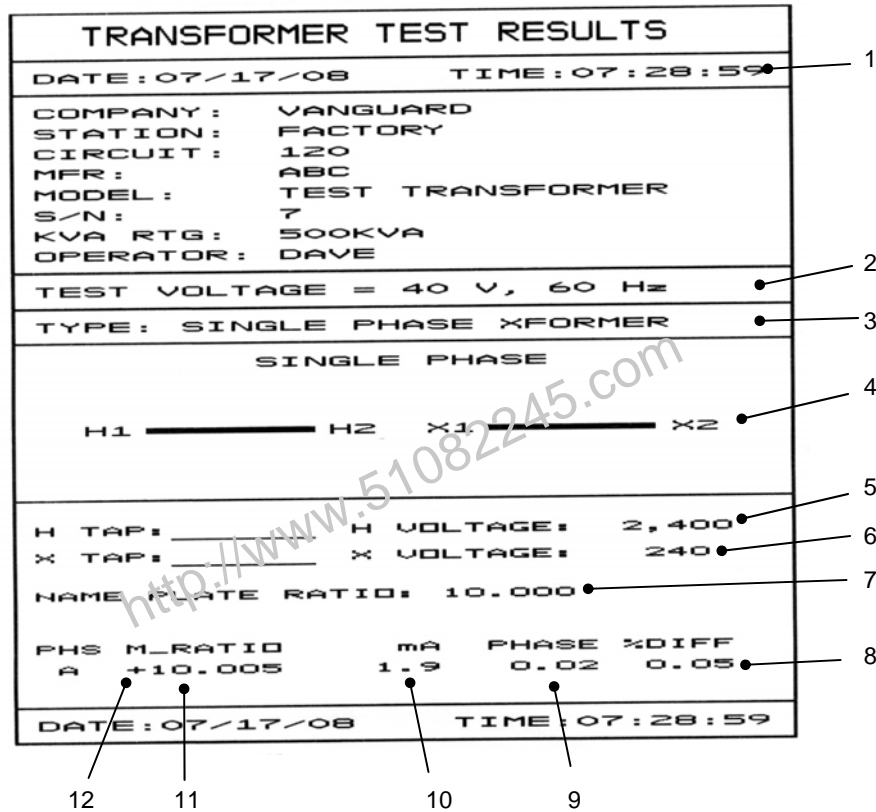

Figure 27.0 Single Phase Column Format Printout

A typical single-phase transformer test results printout in column format is shown in Figure 27.0.

The test results printout is explained below.

1. Test record time and date is printed at the top of the printout
2. Test voltage is 40 volts at 60 Hz for this test. Refer to section 11.2 for more details about test voltages and frequencies
3. Type of transformer under test is single phase
4. Transformer configuration diagram
5. H tap voltage is 2,400 volts
6. X tap voltage is 240 volts
7. Calculated turns-ratio is 10.000
8. Percentage error between calculated ratio and measured ratio is 0.05%
9. Measured winding phase angle is 0.02 degrees
10. Excitation current is 1.9mA
11. Measured ratio is 10.005
12. Winding polarity is shown as “+” or “in phase



13.11 Test Result Detail Format Printout

| TRANSFORMER TEST RESULTS   |                |
|----------------------------|----------------|
| DATE: 07/17/08             | TIME: 07:31:01 |
| COMPANY: VANGUARD          |                |
| STATION: FACTORY           |                |
| CIRCUIT: 120               |                |
| MFR: ABC                   |                |
| MODEL: TEST TRANSFORMER    |                |
| S/N: 7                     |                |
| KVA RTG: 500KVA            |                |
| OPERATOR: DAVE             |                |
| TEST VOLTAGE = 40 V, 60 Hz |                |
| TYPE: SINGLE PHASE XFORMER |                |
| SINGLE PHASE               |                |
|                            |                |
| TEST H1-H2 AND X1-X2       |                |
| NAME PLATE VOLTAGE:        |                |
| H VOLTAGE:                 | 2,400          |
| H TAP SETTING:             |                |
| X VOLTAGE:                 | 240            |
| X TAP SETTING:             |                |
| NAME PLATE RATIO:          | 10.000         |
| MEASURED RATIO:            | 10.005         |
| DIFFERENCE:                | 0.05%          |
| MEASURED PHASE-ANGLE:      | 0.02 DEG       |
| MEASURED CURRENT:          | 1.9 mA         |
| DATE: 07/17/08             | TIME: 07:31:01 |

Figure 28.0 Single Phase Detail Format Printout

**13.11 Test Result Detail Format Printout (continued)**

The same report is now shown in detailed format printout (Figure 28.0).

The test results detail printout is explained below.

1. Test record time and date is printed at the top of the printout
2. Test voltage is 40 volts at 60 Hz for this test. Refer to paragraph 11.2 for more details about test voltages and frequencies
3. Type of transformer under test is Single Phase
4. Transformer configuration diagram
5. H tap voltage is 2,400 volts
6. X tap voltage is 240 volts
7. Calculated turns-ratio is 10.000
8. Measured ratio is 10.005
9. Percentage error between calculated ratio and measured ratio is 0.05%
10. Measured winding phase angle is 0.02 degrees
11. Excitation current is 1.9mA

**NOTE:**

*A phase angle printout of 999.9 indicates an unstable phase angle reading.*

13.12 Keep This Reading Menu

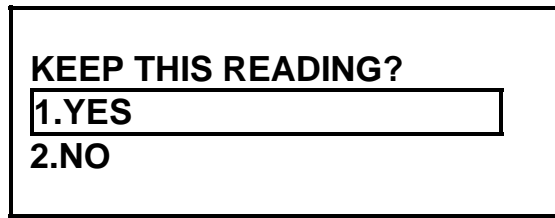

Figure 29.0 Keep This Reading Menu

- a. **Description:** The operator has the option to store the current test result in non-volatile memory or disregard the current test results.
- b. **Origin:** After the operator selects 1 (“YES”) or the operator selects 2 (“NO”) from the “Print Test Results Menu” (Figure 25.0).
- c. **Action Options:** Press key number 1 (“YES”) or push down the Control Knob to store current transformer test results into non-volatile memory. Press key number 2 (“NO”) to disregard the current test results. Number 2 may be selected by turning the Control Knob, then pushing down on Control Knob after 2 is selected.
- d. **Action To Perform:** Select menu option 1 for this example.
- e. **Results of Action:** After selecting menu option 1, the status “TEST SAVED” is displayed on the LCD. Press any key or push down Control Knob to go to the “Run Another Test Menu” (Figure 31.0).

13.13 Previous Data In Buf. Menu

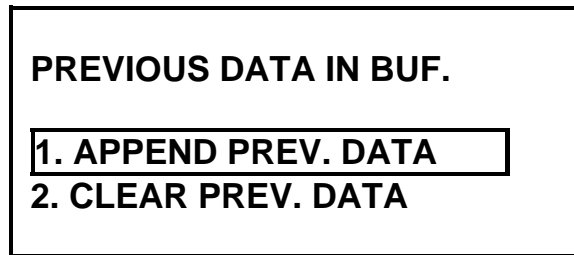

Figure 30.0 Previous Data In Buf Menu

- a. **Description:** This menu is displayed when there is an existing test result in memory of the same type of transformer which is under test.

The “Append Previous Data” feature allows the operator to stop the testing in order to perform other duties. The operator will be able to continue testing the transformer at a later time without having to repeat any of the previous tests. It is important to remember that this may only be accomplished when all tests are performed on the *same transformer*. Figure 30.0 will display when another test is performed on an identical transformer configuration and there is a test record residing in temporary memory (i.e., buf) from an identical transformer configuration. The previous test record may be a restored test record or the current test record for an identical transformer configuration.

For example, a previous single phase transformer configuration test record with one or more test results from a single phase transformer configuration is stored in TRI-PHASE™ FLASH memory. These test results are also still residing in temporary memory. The operator performs another single phase transformer configuration test. The operator selects “YES” in response to “Keep This Reading” at step 14 of Table 5.0 resulting in saving the test results to temporary memory and the display of Figure 30.0.

Selecting menu option 1 (“Append Prev. Data”) will result in appending the current test result to all of the previous test results from the test record stored in temporary memory; assigning this new record to the next test record number in sequence.

Selecting menu option 2 (“Clear Prev. Data”) will result in clearing the temporary memory of all previous test results from the test record except the current test result and assign the current test result to the next sequential test record number.

- b. **Origin:** This menu displays after the operator selects 1 (“YES”) from the “Keep This Reading Menu” (Figure 29.0)
- c. **Action Options:** Press key number 1 to append. Press key number 2 to clear the previous test results from temporary memory and store the current test results in FLASH EEPROM.
- d. **Action To Perform:** Selecting option 1 or 2. After the selection is made the status “TEST SAVED” is displayed. Press any key or push down the Control Knob to advance to the “Run Another Test Menu” (Figure 31.0).

### 13.14 Run Another Test Menu

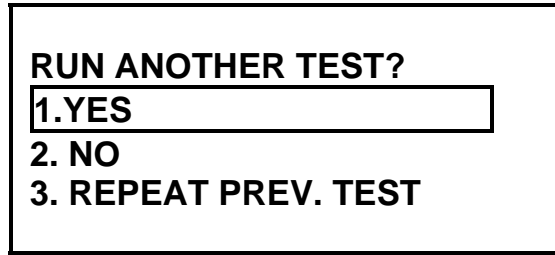

**Figure 31.0 Run Another Test Menu**

- a. **Description:** Allows the selection of performing another test on the transformer, ending testing, or repeating the previous test.
- b. **Origin:** After the “Test Saved Status Display”. Refer to “Keep This Reading” section 13.12.d.
- c. **Action Options:** Press key number 1 (“YES”) or push down the Control Knob. Press key number 2 to end the current test and advance to the “Save This Record Menu” (Figure 32.0). Selection of 2 may be made by turning the Control Knob. Push down the Control Knob after 2 is selected.
- d. **Action To Perform:** Select menu option 2 for this example.

13.15 Save This Record Menu

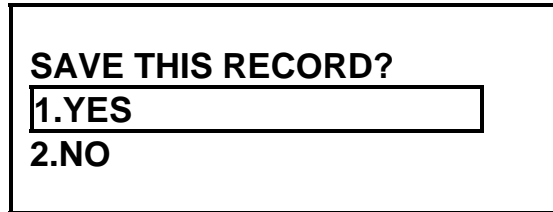

Figure 32.0 Save This Record Menu

- a. **Description:** Allows for the transfer of current test results from the non-volatile memory into FLASH EEPROM. Up to 112 test-records may be stored in FLASH EEPROM.
- b. **Origin:** After selecting key 2 from the “Run Another Test Menu” (Figure 31.0).
- c. **Action Options:** Press key number 1 (“YES”) or push down the Control Knob to save the current test results to a test record. Press key number 2 to disregard the current test results and advance to the “Test Record Not Saved Menu” (Figure 35.0 Test Record Not Saved Menu). Selection of number 2 may be made by turning the Control Knob. Push down the Control Knob after number 2 is selected.
- d. **Action To Perform:** Select menu option 1 for this example.

### 13.16 Record Saved Confirmation Status



**RECORD NUMBER #  
HAS BEEN SAVED!**

**Figure 33.0 Record Saved Confirmation Status Display**

- a. Description:** The current test results are saved into the next sequential test record number (#) assigned. The test record is saved in FLASH EEPROM.
- b. Origin:** Select menu option 1 (“YES”) from the “Save This Record Menu” (Figure 32.0).
- c. Action Options:** Press any key or push down the Control Knob to return to the “Main Menu” (Figure 14.0).
- d. Action To Perform:** Press any key or push down the Control Knob for this example.

13.17 Transformer Name Plate Voltage Menu For Another Test

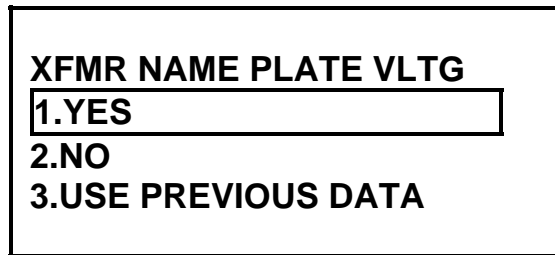
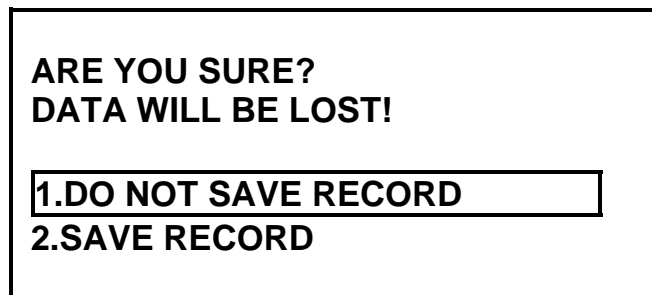

**Figure 34.0 Nameplate Voltage Selection Menu For Another Test**

- a. **Description:** This menu displays when another test is performed. The operator has an added option to use the same nameplate voltage data from the previous test.
- b. **Origin:** After selecting number 1 (“YES”) from the options listed in “Run Another Test Menu” (Figure 31.0) the “Transformer Name Plate Voltage Menu” to perform another test displays.
- c. **Action Options:** Press key number 1 (“YES”) or push down on the Control Knob and advance to the “Name Plate Voltage” display (Figure 18.0). Press key number 2 to bypass this option and advance to the “Start/Stop Test Menu” (Figure 22.0). Press key number 3 to use the same transformer nameplate voltage data from the previous test and advance to the “Start/Stop Test Menu”. Selection of menu items may also be made by turning the Control Knob to select a menu option, then pushing down on the Control Knob once the selection is made.



### 13.18 Test Record Not Saved Menu



**Figure 35.0 Test Record Not Saved Menu**

- a. **Description:** This menu displays after the operator decides to not save the test results to a test record.
- b. **Origin:** Press key number 2 (“NO”) from the “Save This Record Menu” (Figure 32.0).
- c. **Action Options:** Press key number 1 or push down the Control Knob to select not to save the test results to a test record. Press key number 2 to save test results to a test record. Selection of number 2 may be made by turning the Control Knob. Push down the Control Knob after number 2 is selected.

**14.0 Dyn1 Transformer Test Procedure**

Table 6.0 shows the procedure to test a Dyn1 (12,000 V/208 V) transformer.

**Table 6.0 Dyn1 Transformer Test Procedure**

| STEP | DESCRIPTION  | DISPLAY  | ACTION  |
|------|--|--|---|
| 1    | Select "Run Test" from "Main Menu"   | <b>1.RUN TEST</b><br><b>2.SETUP</b><br><b>3.TEST PLAN</b><br><b>4.DIAGNOSTIC</b><br><b>TIME: 20:15:00</b><br><b>DATE: 07/16/08</b> | Press key number 1 or push down Control Knob                            |
| 2    | Select "Dy" (Delta to Wye) from the "Transformer Configuration" first menu             | <b>XFMR CONFIG:</b><br><b>1. SINGLE PHASE</b><br><b>2. Dy</b><br><b>3.Yd</b><br><b>4.Dd</b><br><b>5.Yy</b><br><b>6.Next Page</b>   | Press key number 2 or push down Control Knob                            |
| 3    | Select "YES" from the "X0 Accessible Menu" X0 (neutral)                                | <b>X0 ACCESSIBLE?</b><br><b>1.YES</b><br><b>2.NO</b>   | Press key number 1 or push down Control Knob                            |
| 4    | "Transformer Name Plate Voltage" status display<br>Select "YES"                        | <b>NAME PLATE VOLTAGE</b><br><b>1.YES</b><br><b>2.NO</b>   | Press key number 1 or push down Control Knob                            |
| 5    | "Name Plate Voltage" status display<br>Enter H line voltage from transformer nameplate | <b>NAME PLATE VOLTAGE:</b><br><b>H : X</b><br><b>0 :</b>   | Use keys 0-9 for data entry of transformer name plate voltage           |
| 6    | "Name Plate Voltage" status display<br>Confirm H voltage                               | <b>NAME PLATE VOLTAGE:</b><br><b>H : X</b><br><b>12,000 :</b>  | Press "ENTER" or push down Control Knob (12000 was keyed for this test) |
| 7    | "Name Plate Voltage" status display. Enter X line voltage from transformer nameplate   | <b>NAME PLATE VOLTAGE:</b><br><b>H : X</b><br><b>12,000 : 0</b>  | Use key numbers 0 through 9 for data entry                              |
| 8    | "Name Plate Voltage Status Display"<br>Confirm X voltage                               | <b>NAME PLATE VOLTAGE:</b><br><b>H : X</b><br><b>12,000 : 208</b>  | Press "ENTER" or push down Control Knob (208 was keyed)                 |
| 9    | "Start/Stop Test Status Display"   | <b>"START" TO TEST</b><br><b>OR</b><br><b>"STOP" TO ABORT</b>  | Press START key   |

14.0 Dyn1 Transformer Test Procedure (continued)

Table 6.0 Dyn1 Transformer Test Procedure (continued)

| STEP | DESCRIPTION  | DISPLAY  | ACTION  |
|------|--|--|---|
| 10   | “Test in Progress Status Display”  | <b>TEST IN PROGRESS<br/>PLEASE WAIT...</b>   | None  |
| 11   | “Test Results Status Display”<br>Observe ratio, excitation current, and percentage error on LCD display  | <b>RATIO      mA      %DIFF</b><br><b>A 57.757      2.3      0.11</b><br><b>B 57.754      2.4      0.11</b><br><b>C 57.741      3.4      0.08</b><br><b>XFMR TYPE: Dyn1</b>                                | None    Three-phase test turns-ratio results are shown first.   |
| 12   | “Test Results Status Display”<br>Observe ratio, excitation current, and percentage error on LCD display  | <b>PHASE DATA</b><br><b>Phs A    Phs B    Phs C</b><br><b>30.01    150.00    270.01</b>  | None    Three-phase phase angle test results are briefly shown next.  |
| 13   | “Test Results Status Display”<br>Observe ratio, excitation current, and percentage error on LCD display  | <b>SINGLE PHASE TEST RSLT:</b><br><b>RATIO      mA      %DIFF</b><br><b>A +100.06    2.4      0.14</b><br><b>B +100.02    1.9      0.09</b><br><b>C +100.02    2.6      0.00</b><br><b>XFMR TYPE: Dyn1</b> | None<br>Single-phase test results are displayed last  |
| 14   | “Test Results Status Display”<br>Go to next LCD display  | <b>SINGLE PHASE TEST RSLT:</b><br><b>RATIO      mA      %DIFF</b><br><b>A +100.06    2.4      0.14</b><br><b>B +100.02    1.9      0.09</b><br><b>C +100.02    2.6      0.09</b><br><b>XFMR TYPE: Dyn1</b> | Observe test results<br><br>Press any key or push down Control Knob   |
| 15   | Select “YES” from the “Print Test Results Menu” to print test result on built-in printer   | <b>PRINT TEST RESULTS?</b><br><b>1.YES</b><br><b>2.NO</b>  | Press key number 1 or push down Control Knob  |
| 16   | “Print Format Menu”<br>Select either print format  | <b>PRINT FORMAT</b><br><b>1.COLUMN</b><br><b>2.DETAILED</b>  | Press key number 1 or key number 2. Selection of 1 or 2 may be made by turning the Control Knob. Push down Control Knob after selection is made |
| 17   | Select “YES” from the “Keep This Reading Menu” to store current test reading in non-volatile memory<br><b>NOTE:</b><br>Refer to note at end of table | <b>KEEP THIS READING?</b><br><b>1.YES</b><br><b>2.NO</b>   | Press key number 1 or push down Control Knob  |
| 18   | “Test Saved Status Display”<br>Current test reading is saved   | <b>TEST SAVED</b>  | Press any key or push down Control Knob   |

14.0 Dyn1 Transformer Test Procedure (continued)

Table 6.0 Dyn1 Transformer Test Procedure (continued)

| STEP | DESCRIPTION   | DISPLAY   | ACTION   |
|------|---|---|--|
| 19   | Select "NO" from the "Run Another Test Menu"  | <b>RUN ANOTHER TEST?</b><br><input type="text" value="1.YES"/><br>2.NO<br>3. REPEAT PREV. TEST                        | Press key number 2<br>Selection of 2 may be made by turning the Control Knob. Push down Control Knob after 2 is selected |
| 20   | Store test results in FLASH EEPROM  | <b>SAVE THIS RECORD?</b><br><input type="text" value="1.YES"/><br>2.NO  | Press key number 1 or push down Control Knob   |
| 21   | "Record Saved" confirmation status display<br>Test results saved in FLASH EEPROM as a test record<br>NOTE:<br>The next sequential record number (#) is automatically assigned | <b>RECORD NUMBER # HAS BEEN SAVED</b>   | Press any Key or push down Control Knob  |
| 22   | Return to "Main Menu"   | <input type="text" value="1.RUN TEST"/><br>2.SETUP<br>3.TEST PLAN<br>4.DIAGNOSTIC<br>TIME: 20:15:00<br>DATE: 07/16/08 | None   |

**NOTE:**

The precondition for the above test procedure was that no previous single-phase transformer test record was residing in temporary memory. Once a single phase test record has been saved to FLASH EEPROM, or a single phase test record restored from FLASH EEPROM and another single phase transformer test is performed, select "YES" in response to "Keep This Reading" at step 17 results in the display of the following menu.

|  |
|--|
| <b>PREVIOUS DATA IN BUF.</b>                     |
| <input type="text" value="1.APPEND PREV. DATA"/> |
| <b>2.CLEAR PREV. DATA</b>                        |

The "PREVIOUS DATA IN BUF." menu is displayed when previous test data is stored in temporary memory. Selecting menu option 1 ("Append Prev. Data") will append the current test results to the previous test data stored in temporary memory. Selecting menu option 2 ("Clear Prev. Data") will store only this new test data in the temporary memory (and clear the previous data). The temporary memory will be lost when the TRI-PHASE™ is powered-off, but the test records will remain in the TRI-PHASE™ FLASH EEPROM non-volatile internal memory.

14.1 Delta-To-Wye (Dyn) Transformer Test Column Format Printout

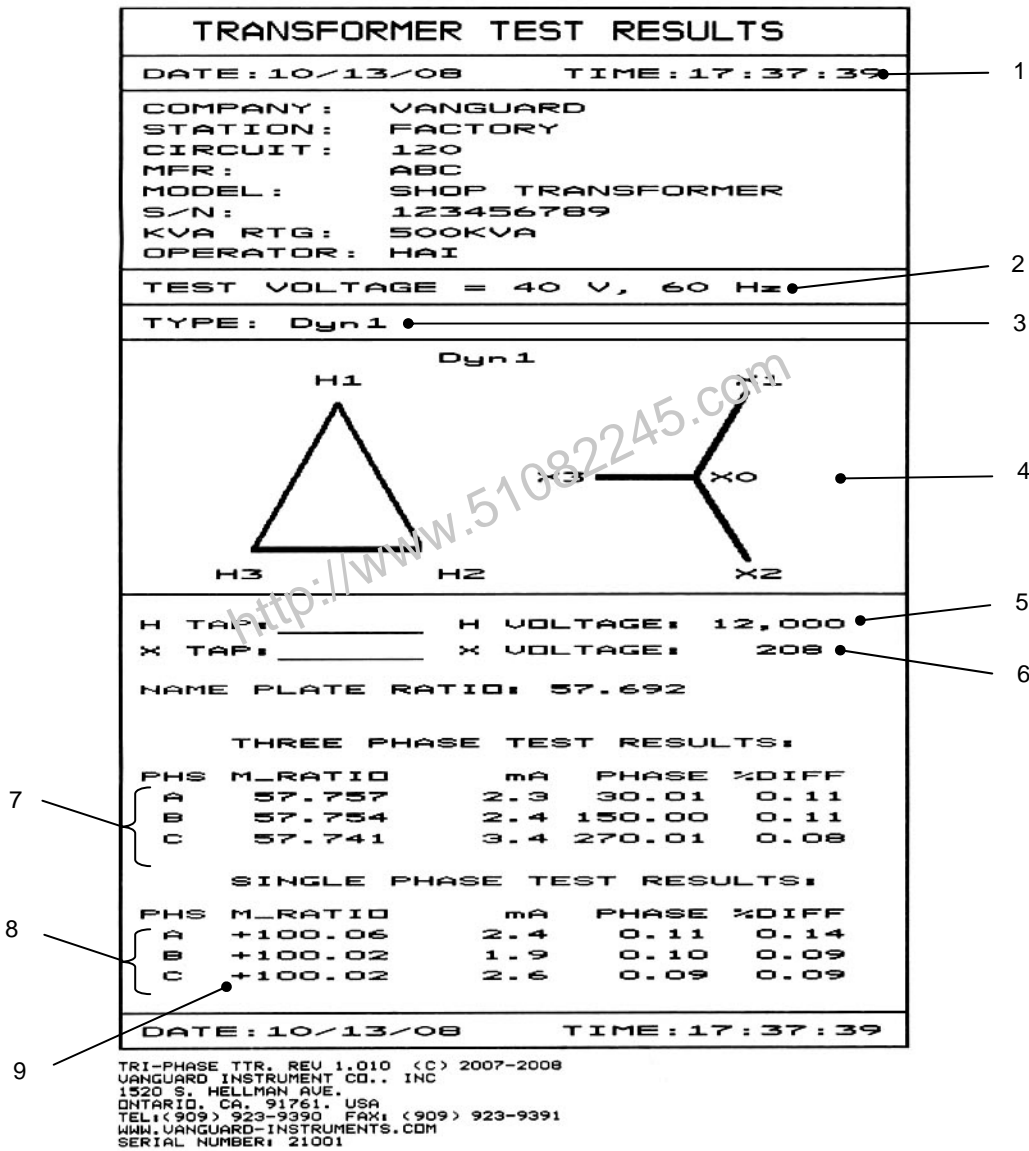

Figure 36.0 Dyn1 Column Format Printout

**14.1 Delta-To-Wye (Dyn) Transformer Test Column Format Printout (continued)**

The delta-wye test results printout is explained below for Figure 36.0.

1. Test record time and date is printed at the top of the printout.
2. Test voltage is 40 volts at 60 Hz for this test. Refer to paragraph 19.0 for more details about test voltages and frequencies.
3. Type of transformer under test is Delta to Wye with X0 available (Dyn1).
4. Transformer configuration diagram.
5. H tap voltage is 12,000 volts.
6. X tap voltage is 208 volts.
7. Three-Phase measured ratio, excitation current, phase angle, % Diff.
  - A phase: Ratio=57.757, Ext Current= 2.3mA, 30.01 degrees, % Diff= 0.11
  - B phase: Ratio=57.754, Ext Current= 2.4mA, 150.00 degrees, % Diff= 0.11
  - C phase: Ratio=57.741, Ext Current= 3.4mA, 270.01 degrees, % Diff= 0.08
8. Single Phase measured ratio, excitation current, phase angle, % Diff.
  - A phase: Ratio=100.06, Ext Current= 2.4mA, 0.11 degrees, % Diff= 0.14
  - B phase: Ratio=100.02, Ext Current= 1.9mA, 0.10 degrees, % Diff= 0.09
  - C phase: Ratio=100.02, Ext Current= 2.6mA, 0.09 degrees, % Diff= 0.09
9. Winding polarity is shown as “+” or in phase.

14.2 Delta-To-Wye Transformer Test Detail Format Printout

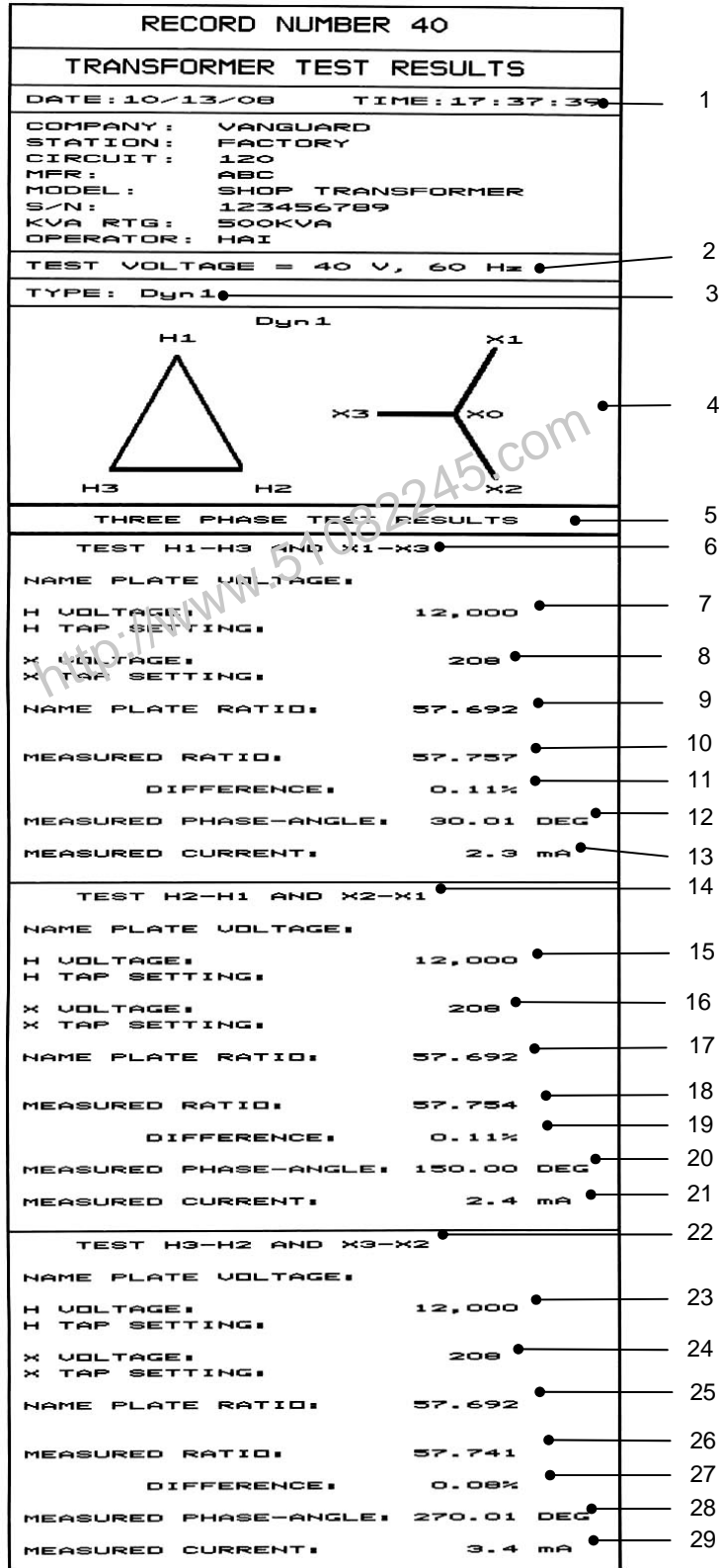

Figure 37.0 Dyn1 Detail Format Printout

14.2 Delta-To-Wye Transformer Test Detail Format Printout (continued)

| SINGLE PHASE TEST RESULTS |          | 30 |
|---------------------------|----------|----|
| TEST H1-H3 AND X1-X0      |          | 31 |
| NAME PLATE VOLTAGE:       |          |    |
| H VOLTAGE:                | 12,000   | 32 |
| H TAP SETTING:            |          |    |
| X VOLTAGE:                | 208      | 33 |
| X TAP SETTING:            |          |    |
| CALCULATED RATIO:         | 99.926   | 34 |
| MEASURED RATIO:           | 100.06   | 35 |
| DIFFERENCE:               | 0.14%    | 36 |
| MEASURED PHASE-ANGLE:     | 0.11 DEG | 37 |
| MEASURED CURRENT:         | 2.4 mA   | 38 |
| TEST H2-H1 AND X2-X0      |          | 39 |
| NAME PLATE VOLTAGE:       |          |    |
| H VOLTAGE:                | 12,000   | 40 |
| H TAP SETTING:            |          |    |
| X VOLTAGE:                | 208      | 41 |
| X TAP SETTING:            |          |    |
| CALCULATED RATIO:         | 99.926   | 42 |
| MEASURED RATIO:           | 100.02   | 43 |
| DIFFERENCE:               | 0.09%    | 44 |
| MEASURED PHASE-ANGLE:     | 0.10 DEG | 45 |
| MEASURED CURRENT:         | 1.9 mA   | 46 |
| TEST H3-H2 AND X3-X0      |          | 47 |
| NAME PLATE VOLTAGE:       |          |    |
| H VOLTAGE:                | 12,000   | 48 |
| H TAP SETTING:            |          |    |
| X VOLTAGE:                | 208      | 49 |
| X TAP SETTING:            |          |    |
| CALCULATED RATIO:         | 99.926   | 50 |
| MEASURED RATIO:           | 100.02   | 51 |
| DIFFERENCE:               | 0.09%    | 52 |
| MEASURED PHASE-ANGLE:     | 0.09 DEG | 53 |
| MEASURED CURRENT:         | 2.6 mA   | 54 |

TRI-PHASE TTR, REV 1.010 (C) 2007-2008  
 VANGUARD INSTRUMENT CO., INC  
 1520 S. HELLMAN AVE.  
 ONTARIO, CA, 91761, USA  
 TEL: (909) 923-9390 FAX: (909) 923-9391  
 WWW.VANGUARD-INSTRUMENTS.COM  
 SERIAL NUMBER: 21001

Figure 37.0 Dyn1 Detail Format Printout (continued)



## 14.2 Delta-To-Wye Transformer Test Detail Format Printout (continued)

The same 3-phase test results are now shown in detailed format printout (Figure 37.0).

The test results printout is explained below:

1. Test record time and date is printed at the top of the printout.
2. Test voltage is 40 volts at 60 Hz for this test. Refer to section 11.2 for more details about test voltages.
3. Type of transformer under test is Delta to Wye with X0 available.
4. Transformer configuration diagram (H and X).
5. **Three Phase Test Results heading** (numbers 6 through 29).
6. Test H1-H3 and X1-X3 heading.
7. H1-H3 tap voltage is 12,000 volts.
8. X1-X3 tap voltage is 208 volts.
9. H1-H3, X1-X3 calculated voltage ratio is 57.692.
10. H1-H3, X1-X3 measured voltage ratio is 57.755.
11. H1-H3, X1-X3 percentage error between calculated ratio and measured ratio is 0.11%.
12. Measured phase angle between H1 to X1 is 30.01 degrees.
13. H1-H3 measured excitation current is 2.3mA.
14. Test H2-H1 and X2-X1 heading.
15. H2-H1 tap voltage is 12,000 volts.
16. X2-X1 tap voltage is 208 volts.
17. H2-H1, X2-X1 calculated voltage ratio is 57.692.
18. H2-H1, X2-X1 measured voltage ratio is 57.754.
19. H2-H1, X2-X1 percentage error between calculated ratio and measured ratio is 0.11%.
20. Measured phase angle between H1 to X2 is 150.01 degrees.
21. H2-H1 measured excitation current is 2.4mA.
22. Test H3-H2 and X3-X2 heading.
23. H3-H2 tap voltage is 12,000 volts.
24. X3-X2 tap voltage is 208 volts.
25. H3-H2, X3-X2 calculated voltage ratio is 57.692.
26. H3-H2, X3-X2 measured voltage ratio is 57.741.
27. H3-H2, X3-X2 percentage error between calculated ratio and measured ratio is 0.08%.
28. Measured phase angle between H1 to X3 is 270.01 degrees.
29. H3-H2 measured excitation current is 3.4mA.

**14.2 Delta-To-Wye Transformer Test Detail Format Printout (continued)**

30. **Single Phase Test Results** (numbers 31 through 54).
31. Test H1-H3 and X1-X0 heading.
32. H1-H3 tap voltage is 12,000 volts.
33. X1-X0 tap voltage is 208 volts.
34. H1-H3, X1-X0 name plate calculated voltage ratio is 99.926.
35. H1-H3, X1-X0 measured voltage ratio is 100.06.
36. H1-H3, X1-X0 percentage error between calculated ratio and measured ratio is 0.14%.
37. H1-H3, X1-X0 measured phase angle is 0.11 degrees.
38. H1-H3 measured excitation current is 2.4mA.
39. Test H2-H1 and X2-X0 heading.
40. H3-H2 tap voltage is 12,000 volts.
41. X2-X0 tap voltage is 208 volts.
42. H2-H1, X2-X0 name plate calculated voltage ratio is 99.926.
43. H2-H1, X2-X0 measured voltage ratio is 100.02.
44. H2-H1, X2-X0 percentage error between calculated ratio and measured ratio is 0.09%.
45. H2-H1, X2-X0 measured phase angle is 0.10 degrees.
46. H2-H1 measured excitation current is 1.9mA.
47. Test H3-H2 and X3-X0 heading.
48. H3-H2 tap voltage is 12,000 volts.
49. X3-X0 tap voltage is 208 volts.
50. H3-H2, X3-X0 name plate calculated voltage ratio is 99.926.
51. H3-H2, X3-X0 measured voltage ratio is 100.02.
52. H3-H2, X3-X0 percentage error between calculated ratio and measured ratio is 0.09%.
53. H3-H2, X3-X0 measured phase angle is 0.09 degrees.
54. H3-H2 measured excitation current is 2.6mA.

**15.0 Auto Detect Transformer Configuration Capability**

The auto detect feature of the TRI-PHASE™ enables it to detect the specific transformer configuration. The user only has to select the general transformer configuration for test (for examples, see figures Figure 15.0 Transformer Configuration Selection First Menu and Figure 16.0 Transformer Configuration Selection Second Menu). The TRI-PHASE™ will identify the specific transformer configuration and run the test. The TRI-PHASE™ is capable of detecting the vector diagrams of the following transformer types.

|             |              |
|-------------|--------------|
| Delta-Delta | Delta-ZigZag |
| Wye-Wye     | ZigZag-Delta |
| Delta-Wye   | ZigZag-Wye   |
| Wye-Delta   | T Type       |

The transformer configurations supported by TRI-PHASE™ are listed in Appendix B. Once the correct three phase transformer configuration is identified, the TRI-PHASE™ will perform the turns ratio test.

16.0 Test Record Options

16.1 Restore A Test Record To Print Procedure

The following procedure allows the operator to restore a test record from FLASH EEPROM.

Table 7.0 Restore A Test Record To Print Procedure

| STEP | DESCRIPTION  | DISPLAY  | ACTION   |
|------|--|--|--|
| 1    | Select "Setup" from the "Main Menu"  | <b>1.RUN TEST</b><br><b>2.SETUP</b><br><b>3.TEST PLAN</b><br><b>4.DIAGNOSTIC</b><br><b>TIME: 20:15:00</b><br><b>DATE: 07/16/08</b>                   | Press key number 2<br>Selection of 2 may be made by turning the Control Knob. Push down Control Knob after 2 is selected |
| 2    | Select "Save/Restore Record" from the "Setup Menu"                             | <b>1.RECORD ID</b><br><b>2.TEST VOLTAGE</b><br><b>3.TEST FREQUENCY</b><br><b>4.PRINT RECORD</b><br><b>5.SAVE/RESTORE RECORD</b><br><b>6.SET TIME</b> | Press key number 5<br>Selection of 5 may be made by turning the Control Knob. Push down Control Knob after 5 is selected |
| 3    | Select "Restore Record" from the "Save/Restore Menu"                           | <b>1.RESTORE RECORD</b><br><b>2.SAVE RECORD</b><br><b>3.RECORD DIRECTORY</b><br><b>4.ERASE RECORD</b>  | Press key number 1 or push down Control Knob   |
| 4    | Select "Enter Record Number" from the "Restore Record Menu"                    | <b>RESTORE RECORD</b><br><b>1.ENTER RECORD NUMBER</b><br><b>2.SCROLL TO SELECT</b>   | Press key number 1 or push down on the Control Knob  |
| 5    | "Restore Record Number Status" display<br>Enter record number to be restored   | <b>RESTORE RECORD</b><br><b>NUMBER:</b>  | Use keys 0-9 to enter record number<br>(41 was entered)  |
| 6    | Confirm record number  | <b>RESTORE RECORD</b><br><b>NUMBER: 41</b>   | Press "ENTER" key to confirm   |
| 7    | "Record Restored Menu"<br>Record recalled from FLASH EEPROM to volatile memory | <b>RECORD RESTORED!</b><br><b>PRINT RECORD?</b><br><b>1.YES</b><br><b>2.NO</b>   | Press key 1 or push down Control Knob  |
| 8    | "Print Record Menu"  | <b>PRINT RECORD</b><br><b>1.PRINT TO LCD</b><br><b>2.PRINT TO PRINTER</b>  | Press key number 2<br>Selection of 2 may be made by turning the Control Knob. Push down Control Knob after 2 is selected |

16.1 Restore A Test Record Procedure (continued)

Table 7.0 Restore A Test Record To Print Procedure (continued)

| STEP | DESCRIPTION                                       | DISPLAY  | ACTION  |
|------|---|--|---|
| 9    | “Print Format Menu”<br>Select either print format | <b>PRINT FORMAT?</b><br><b>1.COLUMN</b><br><b>2.DETAILED</b>   | Press key number 1 or key number 2. Selection of 1 or 2 may be made by turning the Control Knob. Push down Control Knob after selection is made |
| 10   | Test record is printed                            | <b>PLEASE WAIT...<br/>PRINTING REPORT</b>  | None  |
| 11   | Return to “Main Menu”                             | <b>1.RUN TEST</b><br><b>2.SETUP</b><br><b>3.TEST PLAN</b><br><b>4.DIAGNOSTIC</b><br>TIME: 20:15:00<br>DATE: 07/16/08 | None  |

16.2 Setup Menu

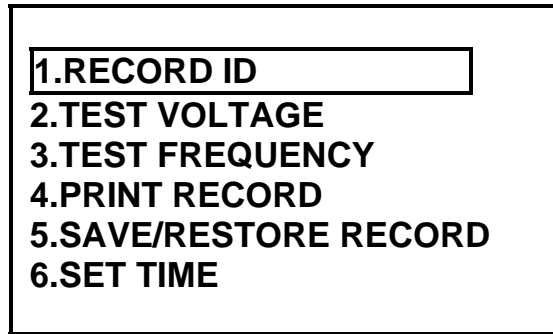

Figure 38.0 Setup Menu

- a. **Description:** Allows the operator to select other operational features of the TRI-PHASE™ test device.
- b. **Origin:** From the “Main Menu” (Figure 14.0) select menu option 2.
- c. **Action Options:** Press key number 1 or push down on the Control Knob to select the status displays for editing the record identification (ID) which is printed with each test result or test record. Press key number 2 to select the “Test Voltage Menu”. Press key number 3 to select the “Test Frequency Menu”. Press key number 4 to select the “Print Record Menu” for printing the current test record. Press key number 5 to select the “Save/Restore Record Menu”. Press key number 6 to display the status displays for editing the time and date settings. Selection of 2, 3, 4, 5, or 6 may be made by turning the Control Knob to the desired number and pushing down the Control Knob after it is selected.
- d. **Action To Perform:** Restore record #41. Select menu option 5 for this example.

### 16.3 Save/Restore Record Menu



**Figure 39.0 Save/Restore Record Menu**

- a. **Description:** Allows the operator to restore a test record, save a test record, print a directory of test records, erase a single test record, or erase all test records.
- b. **Origin:** From the “Setup Menu” (Figure 38.0) select menu option 5.
- c. **Action Options:** Press key number 1 or push down Control Knob to select the “Restore Record Menu”. Press key number 2 to select the “Save Record Menu”. Press key number 3 to select the “Record Directory Menu”. Press key number 4 to select the “Erase Record Menu”.
- d. **Action To Perform:** Select menu option 1 for this example.

## 16.4 Restore Record Menu

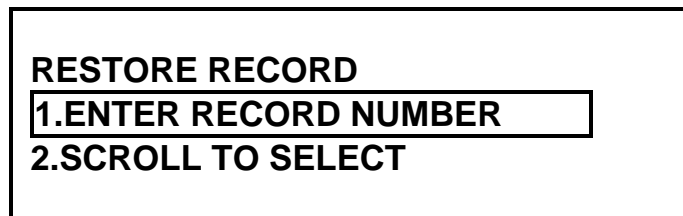

**Figure 40.0 Restore Record Menu**

- a. **Description:** Allows the operator to restore a test record.
- b. **Origin:** From the “Save/Restore Record Menu” (Figure 39.0) select menu option 1.
- c. **Action Options:** Press key number 1 or push down on the Control Knob to select “Enter Record Number” option. Press key number 2 to select “Scroll To Select” option. Selection of number 2 may be made by turning the Control Knob and pushing down the Control Knob after number 2 is selected.
- d. **Action To Perform:** Select menu option 1 for this example.

16.5 Restore Record Number Status Display



Figure 41.0 Restore Record Number Status Display

- a. **Description:** The operator enters the record number to restore.
- b. **Origin:** From the “Restore Record Menu” (Figure 40.0) selection menu option 1.
- c. **Action Options:** Enter the record number to restore by pressing on the key numbers 0 through 9 and pressing “ENTER” to confirm. When an incorrect number(s) is/are pressed, then pressing “CLEAR” before pressing “ENTER” clears the number(s) displayed and allows for another number to be keyed.
- d. **Action To Perform:** Restore record #41. Press key number 4, then key number 1 (i.e., 41 displayed) then press “ENTER” for this example.

**NOTE:**

*If test record 41 does not exist, then use any record number the operator chooses to restore.*



16.6 Record Restored Menu

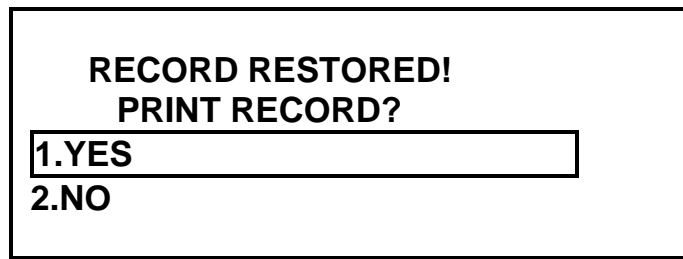
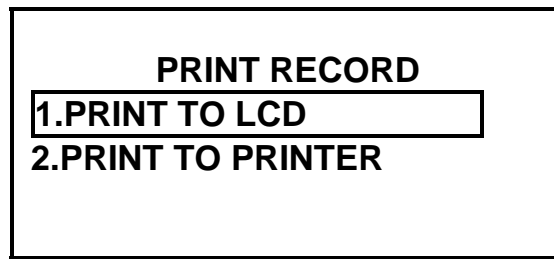

Figure 42.0 Record Restored Menu

- a. **Description:** Allows the operator to decide to print or not print the restored record. Selecting menu option 1 (“YES”) allows for viewing of the record on the LCD screen or printing to the printer.
- b. **Origin:** Pressing “ENTER” from the “Restore Record Number Status Display” after test record number is keyed in (Figure 41.0).
- c. **Action Options:** Press key number 1 (“YES”) or push down on the Control Knob to advance to the “Print Record Menu”. Press key number 2 to select “NO” option. Selection of number 2 may be made by turning the Control Knob and pushing down the Control Knob after number 2 is selected.
- d. **Action To Perform:** Select menu option 1 for this example.

16.7 Print Record To LCD Or Printer Menu



**Figure 43.0 Print Record Menu**

- a. **Description:** Allows the operator to decide to display the restored test record on the LCD or print the restored record.
- b. **Origin:** Selecting menu option 1 (“YES”) from the “Record Restored Menu” (Figure 42.0).
- c. **Action Options:** Press key number 1 to select “PRINT TO LCD” option. The record data is displayed on the LCD when selecting to print to LCD. Press key number 2 to select “PRINT TO PRINTER” option. Selection of number 2 may be made by turning the Control Knob and pushing down the Control Knob after number 2 is selected. The test record is displayed on the LCD.
- d. **Action To Perform:** Select menu option 2 for this example.

16.8 Print Format Menu

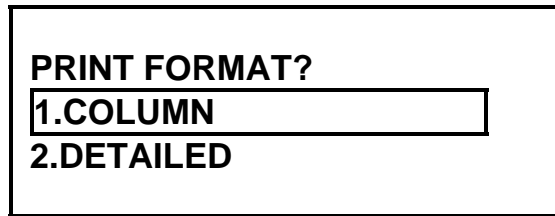

Figure 44.0 Print Format Menu

- a. **Description:** Allows the operator to select which format to use for printing the test record. Refer to Figure 45.0 for a typical test record column format printout. Refer to Figure 46.0 for a typical test record detailed format printout.
- b. **Origin:** This menu is displayed after the operator selects menu option 2 from the “Print Record Menu” (Figure 43.0 Print Record Menu).
- c. **Action Options:** Press key number 1 or push down the Control Knob to select the column format. Press key number 2 for detail format or by turning the Control Knob and push down the Control Knob after number 2 is selected.
- d. **Action To Perform:** Either menu option 1 or 2 from step c may be selected.
- e. **Results of Action Performed:** Once the print format is selected the test report is printed and the LCD displays the following status message momentarily, then displays the “Main Menu”.



16.9 Test Record Printout Column Format

| TRANSFORMER TEST RESULTS   |                   |     |        |       |
|----------------------------|-------------------|-----|--------|-------|
| DATE: 10/13/08             | TIME: 17:37:39    |     |        |       |
| COMPANY: VANGUARD          | STATION: FACTORY  |     |        |       |
| CIRCUIT: 120               | MFR: ABC          |     |        |       |
| MODEL: SHOP TRANSFORMER    | S/N: 123456789    |     |        |       |
| KVA RTG: 500KVA            | OPERATOR: HAI     |     |        |       |
| TEST VOLTAGE = 40 V, 60 Hz |                   |     |        |       |
| TYPE: Dyn1                 |                   |     |        |       |
|                            |                   |     |        |       |
| H TAP: _____               | H VOLTAGE: 12,000 |     |        |       |
| X TAP: _____               | X VOLTAGE: 208    |     |        |       |
| NAME PLATE RATIO: 57.692   |                   |     |        |       |
| THREE PHASE TEST RESULTS:  |                   |     |        |       |
| PHS                        | M/RATIO           | mA  | PHASE  | %DIFF |
| A                          | 57.757            | 2.3 | 30.01  | 0.11  |
| B                          | 57.754            | 2.4 | 150.00 | 0.11  |
| C                          | 57.741            | 3.4 | 270.01 | 0.08  |
| SINGLE PHASE TEST RESULTS: |                   |     |        |       |
| PHS                        | M/RATIO           | mA  | PHASE  | %DIFF |
| A                          | +100.06           | 2.4 | 0.11   | 0.14  |
| B                          | +100.02           | 1.9 | 0.10   | 0.09  |
| C                          | +100.02           | 2.6 | 0.09   | 0.09  |
| DATE: 10/13/08             | TIME: 17:37:39    |     |        |       |

TRI-PHASE TTR, REV 1.010 (C) 2007-2008  
 VANGUARD INSTRUMENT CO., INC  
 1520 S. HELLMAN AVE.  
 ONTARIO, CA, 91761, USA  
 TEL: (909) 923-9390 FAX: (909) 923-9391  
 WWW.VANGUARD-INSTRUMENTS.COM  
 SERIAL NUMBER: 21001

Figure 45.0 Test Record Printout Column Format

16.10 Test Record Printout Detailed Format

| RECORD NUMBER 40   |            |
|--|------------|
| TRANSFORMER TEST RESULTS   |            |
| DATE: 10/13/08      TIME: 17:37:39   |            |
| COMPANY: VANGUARD<br>STATION: FACTORY<br>CIRCUIT: 120<br>MFR: ABC<br>MODEL: SHOP TRANSFORMER<br>S/N: 123456789<br>KVA RTG: 500KVA<br>OPERATOR: HAI |            |
| TEST VOLTAGE = 40 V, 60 Hz   |            |
| TYPE: Dyn1   |            |
|  |            |
| THREE PHASE TEST RESULTS   |            |
| TEST H1-H2 AND X1-X2   |            |
| NAME PLATE VOLTAGE:  |            |
| H VOLTAGE:   | 12,000     |
| H TAP SETTING:   |            |
| X VOLTAGE:   | 208        |
| X TAP SETTING:   |            |
| NAME PLATE RATIO:  | 57.692     |
| MEASURED RATIO:  | 57.757     |
| DIFFERENCE:  | 0.11%      |
| MEASURED PHASE-ANGLE:  | 30.01 DEG  |
| MEASURED CURRENT:  | 2.3 mA     |
| TEST H2-H1 AND X2-X1   |            |
| NAME PLATE VOLTAGE:  |            |
| H VOLTAGE:   | 12,000     |
| H TAP SETTING:   |            |
| X VOLTAGE:   | 208        |
| X TAP SETTING:   |            |
| NAME PLATE RATIO:  | 57.692     |
| MEASURED RATIO:  | 57.754     |
| DIFFERENCE:  | 0.11%      |
| MEASURED PHASE-ANGLE:  | 150.00 DEG |
| MEASURED CURRENT:  | 2.4 mA     |
| TEST H3-H2 AND X3-X2   |            |
| NAME PLATE VOLTAGE:  |            |
| H VOLTAGE:   | 12,000     |
| H TAP SETTING:   |            |
| X VOLTAGE:   | 208        |
| X TAP SETTING:   |            |
| NAME PLATE RATIO:  | 57.692     |
| MEASURED RATIO:  | 57.741     |
| DIFFERENCE:  | 0.08%      |
| MEASURED PHASE-ANGLE:  | 270.01 DEG |
| MEASURED CURRENT:  | 3.4 mA     |

Figure 46.0 Test Record Printout Detailed Format

16.10 Test Record Printout Detailed Format (continued)

| SINGLE PHASE TEST RESULTS |          |
|---------------------------|----------|
| TEST H1-H3 AND X1-X0      |          |
| NAME PLATE VOLTAGE:       |          |
| H VOLTAGE:                | 12,000   |
| H TAP SETTING:            |          |
| X VOLTAGE:                | 208      |
| X TAP SETTING:            |          |
| CALCULATED RATIO:         | 99.926   |
| MEASURED RATIO:           | 100.06   |
| DIFFERENCE:               | 0.14%    |
| MEASURED PHASE-ANGLE:     | 0.11 DEG |
| MEASURED CURRENT:         | 2.4 mA   |
| TEST H2-H1 AND X2-X0      |          |
| NAME PLATE VOLTAGE:       |          |
| H VOLTAGE:                | 12,000   |
| H TAP SETTING:            |          |
| X VOLTAGE:                | 208      |
| X TAP SETTING:            |          |
| CALCULATED RATIO:         | 99.926   |
| MEASURED RATIO:           | 100.02   |
| DIFFERENCE:               | 0.09%    |
| MEASURED PHASE-ANGLE:     | 0.10 DEG |
| MEASURED CURRENT:         | 1.9 mA   |
| TEST H3-H2 AND X3-X0      |          |
| NAME PLATE VOLTAGE:       |          |
| H VOLTAGE:                | 12,000   |
| H TAP SETTING:            |          |
| X VOLTAGE:                | 208      |
| X TAP SETTING:            |          |
| CALCULATED RATIO:         | 99.926   |
| MEASURED RATIO:           | 100.02   |
| DIFFERENCE:               | 0.09%    |
| MEASURED PHASE-ANGLE:     | 0.09 DEG |
| MEASURED CURRENT:         | 2.6 mA   |

TRI-PHASE TTR, REV 1.010 (C) 2007-2008  
 VANGUARD INSTRUMENT CO., INC  
 1520 S. HELLMAN AVE.  
 ONTARIO, CA, 91761, USA  
 TEL: (909) 923-9990 FAX: (909) 923-9391  
 WWW.VANGUARD-INSTRUMENTS.COM  
 SERIAL NUMBER: 21001

Figure 46.0 Test Record Printout Detailed Format (continued)

**16.11 Save Test Results To A Test Record Procedure**

The following procedure allows the operator to save test results to a test record. The operator may perform one or more transformer tests of an identical transformer configuration, each time saving the test results in working memory. All of the test results remain in the temporary memory at the completion of the testing. At that time the operator decides to save all of the test results to a test record in flash memory and performs the following procedure. This procedure allows the operator to perform multiple tests quickly without generating a test record for each individual test performed.

**Table 8.0 Save Test Results To A Test Record Procedure**

| STEP | DESCRIPTION  | DISPLAY   | ACTION  |
|------|--|---|---|
| 1    | Perform one or more transformer test(s) and save the test results each time but do not save the test results to a test record until all testing is completed | refer to Table 5.0 or to Table 6.0  | Perform a transformer test using Table 5.0 steps 1 through 11, steps 12 and 13 are optional, save the test results at step 14<br>Select menu option 1 or 3 from the "Run Another Test Menu" at step 16 of Table 5.0 or step 17 of Table 6.0 each time a test is performed |
| 2    | When no more tests are to be performed select menu option 2 ("NO") from the "Run Another Test Menu" at step 16 of Table 5.0 or step 17 of Table 6.0          | <b>RUN ANOTHER TEST?</b><br>1.YES <input type="text"/><br>2.NO<br>3. REPEAT PREV. TEST                        | Press key number 2<br>Selection of 2 may be made by turning the Control Knob. Push down Control Knob after 2 is selected  |
| 3    | Select menu option 1 ("YES") from the "Save This Record Menu"<br>NOTE:<br>Refer to note at end of Table 5.0 or Table 6.0                                     | <b>SAVE THIS RECORD?</b><br>1.YES <input type="text"/><br>2.NO  | Press key number 1 or push down Control Knob  |
| 4    | Test record confirmation status display<br>All test results saved to a test record   | <b>RECORD NUMBER # HAS BEEN SAVED!</b>  | Press any key or push down Control Knob   |
| 5    | Return to "Main Menu"  | 1.RUN TEST <input type="text"/><br>2.SETUP<br>3.TEST PLAN<br>4.DIAGNOSTIC<br>TIME: 20:15:00<br>DATE: 07/16/08 | None  |

**16.12 Print Test Record Directory**

The following procedure allows the operator to print the directory of test records stored in FLASH EEPROM.

**Table 9.0 Print Test Record Directory Procedure**

| STEP | DESCRIPTION  | DISPLAY   | ACTION  |
|------|--|---|---|
| 1    | Select "Setup" from the "Main Menu"                      | <b>1.RUN TEST</b><br>2.SETUP<br>3.TEST PLAN<br>4.DIAGNOSTIC<br>TIME: 20:15:00<br>DATE: 07/16/08                   | Press key number 2<br><br>Selection of 2 may be made by turning the Control Knob. Push down Control Knob after 2 is selected  |
| 2    | Select "Save/Restore Record" from the "Setup Menu"       | <b>1.RECORD ID</b><br>2.TEST VOLTAGE<br>3.TEST FREQUENCY<br>4.PRINT RECORD<br>5.SAVE/RESTORE RECORD<br>6.SET TIME | Press key number 5<br><br>Selection of 5 may be made by turning the Control Knob. Push down Control Knob after 5 is selected  |
| 3    | Select "Record Directory" from the "Save/Restore Menu"   | <b>1.RESTORE RECORD</b><br>2.SAVE RECORD<br>3.RECORD DIRECTORY<br>4.ERASE RECORD                                  | Press key number 3<br><br>Selection of 3 may be made by turning the Control Knob. Push down Control Knob after 3 is selected  |
| 4    | Select "Short directory" from the "Print Directory Menu" | <b>PRINT DIRECTORY</b><br><b>1.FULL DIRECTORY</b><br>2.SHORT DIRECTORY  | Press key number 1 or push down Control Knob<br>OR<br>Press key number 2. Selection of 2 may also be made by turning the Control Knob. Push down Control Knob after 2 is selected |
| 5    | Return to "Main Menu"                                    | <b>1.RUN TEST</b><br>2.SETUP<br>3.TEST PLAN<br>4.DIAGNOSTIC<br>TIME: 20:15:00<br>DATE: 07/16/08                   | None  |



### 16.13 Print Directory Menu



**Figure 47.0 Print Directory Menu**

- a. **Description:** Allows the operator to print a short directory or full directory of test record headers. Selecting the short directory will print the last ten record headers stored in FLASH EEPROM. Selecting the full directory will print all test record headers stored in FLASH EEPROM.
- b. **Origin:** From the “Save/Restore Menu” (Figure 39.0) select menu option 3.
- c. **Action Options:** Press key number 1 to print all the test record headers. Press key number 2 to print the short directory of the last ten test record headers. Selection of number 2 may be made by turning the Control Knob and pushing down the Control Knob after number 2 is selected.
- d. **Action To Perform:** Select either menu option 1 or 2.
- e. **Result of Action:** The test record directory is printed and the “Main Menu” is displayed on the LCD.

### 16.14 Record Directory Printout

The TRI-PHASE™ record directory printout shows a total of 3 records stored in FLASH EEPROM memory. Record #33 is a single-phase transformer with one test result in record. Record #34 is a single-phase transformer with two test results in record. Record #35 is a Delta to Wye transformer with one test result in record.

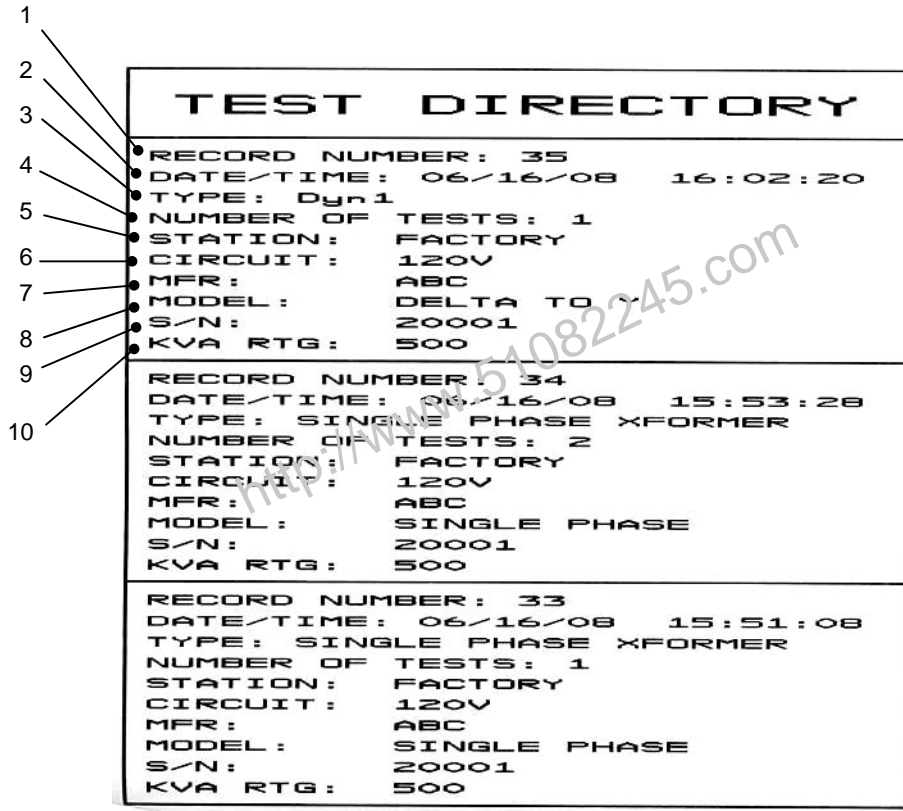

Figure 48.0 Record Directory Printout

The test results printout is explained below:

1. Record number
2. Date and time
3. Type of transformer configuration tested
4. Number of test results in record
5. Name of substation
6. Circuit voltage
7. Manufacturer of transformer
8. Model of transformer
9. Serial number of transformer
10. KVA rating of transformer

**16.15 Restore Test Record To LCD Procedure**

The following procedure allows the operator to restore a test record from FLASH EEPROM and display it on the LCD for viewing.

**Table 10.0 Restore Test Record To LCD Procedure**

| STEP | DESCRIPTION  | DISPLAY   | ACTION   |
|------|--|---|--|
| 1    | Select "Setup" from the "Main Menu"  | <b>1.RUN TEST</b><br><b>2.SETUP</b><br><b>3.TEST PLAN</b><br><b>4.DIAGNOSTIC</b><br><b>TIME: 20:15:00</b><br><b>DATE: 07/16/08</b>                    | Press key number 2<br>Selection of 2 may be made by turning the Control Knob. Push down Control Knob after 2 is selected |
| 2    | Select "Save/Restore Record" from the "Setup Menu"   | <b>1.RECORD ID</b><br><b>2.TEST VOLTAGE</b><br><b>3.TEST FREQUENCY</b><br><b>4.PRINT RECORD</b><br><b>5.SAVE/RESTORE RECORD</b><br><b>6.SET TIME</b>  | Press key number 5<br>Selection of 5 may be made by turning the Control Knob. Push down Control Knob after 5 is selected |
| 3    | Select "Restore Record" from the "Save/Restore Menu"   | <b>1.RESTORE RECORD</b><br><b>2.SAVE RECORD</b><br><b>3.RECORD DIRECTORY</b><br><b>4.ERASE RECORD</b>   | Press key number 1 or push down on the Control Knob  |
| 4    | Select "Enter Record Number" from the "Restore Record Menu"  | <b>RESTORE RECORD</b><br><b>1. ENTER RECORD NUMBER</b><br><b>2.SCROLL TO SELECT</b>   | Press key number 2<br>Selection of 2 may be made by turning the Control Knob. Push down Control Knob after 2 is selected |
| 5    | Scrolling through the test records for viewing on the LCD is enabled   | <b>RECORDS DIRECTORY</b><br><br><b>"UP" TO SCROLL FWD</b><br><b>"DWN" TO SCROLL REV</b>   | See note at bottom of this page  |
| 6    | "Restored Record Status Display"<br>Either the first test record is displayed, or the last test record is displayed on the LCD<br>Scrolling will either advance or reverse through all stored test records | <b>#43      07/17/08      07:28:59</b><br><b>1 TESTS</b><br><br><b>FACTORY</b><br><b>120V</b><br><b>120V</b><br><b>ABC</b><br><b>TEST TRANSFORMER</b> | None<br><br>(test record number 43 selected for this example)  |

**NOTE:**

*Pressing the "PAPER ▲ CONTRAST" key displays the first record stored in FLASH EEPROM.  
Pressing the "PAPER ▼ CONTRAST" key displays the last record stored in FLASH EEPROM.*

16.15 Restore Test Record To LCD Procedure (continued)

Table 10.0 Restore Test Record To LCD Procedure (continued)

| STEP | DESCRIPTION   | DISPLAY   | ACTION  |
|------|---|---|---|
| 7    | “Restored Record Status Display”<br>Observe test record displayed on LCD        | #43 07/17/08 07:28:59<br>1 TESTS<br><br>FACTORY<br>120V<br>120V<br>ABC<br>TEST TRANSFORMER        | None<br><br>After viewing the test record header press “ENTER” or push down Control Knob to restore the record                              |
| 8    | “Record Restored Menu”<br>Record recalled from FLASH EEPROM to temporary memory | RECORD RESTORED!<br>PRINT RECORD?<br>1.YES<br>2.NO  | Press key number 1 or push down on the Control Knob   |
| 9    | “Print Record Restored Menu”<br>Display test record to LCD or print test record | PRINT RECORD<br>1.PRINT TO LCD<br>2.PRINT TO PRINTER  | Press key number 1 or push down on the Control Knob   |
| 10   | “Restored Record First Status Display”  | SINGLE PHASE<br>Num Tests: 1<br>0717/08 07:28:59<br><br>FACTORY<br>120<br>ABC<br>TEST TRANSFORMER | Observe first part of test record displayed on LCD<br><br>Press key number 1 or push down on the Control Knob to view remaining test record |
| 11   | “Restored Record Second Status Display”   | 1 SINGLE PHASE<br>40 VOLTS<br><br>SINGLE-PHASE RESULTS:<br>RATIO mA %DIFF<br>+10.005 1.9 0.05     | Observe second part of test record displayed on LCD<br><br>Press “STOP” to return to “Main Menu”  |
| 12   | Return to “Main Menu”   | 1.RUN TEST<br>2.SETUP<br>3.TEST PLAN<br>4.DIAGNOSTIC<br>TIME: 20:15:00<br>DATE: 07/16/08          | None  |

**NOTE:**

After viewing the test record, another test record may be viewed by pressing either the “PAPER ▲ CONTRAST” key or the “PAPER ▼ CONTRAST” key and repeating steps 5 and 6. When all desired records have been viewed press “ENTER” to advance to step 8.

16.16 Scroll Test Record Menu

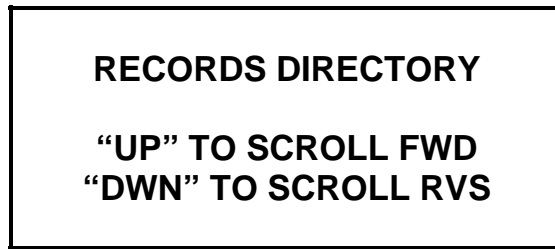

**Figure 49.0 Scroll Test Record Menu**

- a. **Description:** Allows the operator to scroll in forward or reverse order through all of the test records stored in FLASH EEPROM.
- b. **Origin:** This menu is displayed after the operator selects menu option 2 from the “Restore Record Menu” (Figure 40.0).
- c. **Action Options:**  
 Pressing the “PAPER ▲ CONTRAST” key displays the first test record header stored in FLASH EEPROM. Thereafter each instance of pressing the “PAPER ▲ CONTRAST” key displays the next higher sequential test record header stored in FLASH EEPROM. Pressing the “PAPER ▼ CONTRAST” key displays the next lower sequential test header stored in FLASH EEPROM. Pressing “PAPER ▼ CONTRAST” key when the first test record is displayed will return the LCD display to Figure 49.0.  
  
 Pressing the “PAPER ▼ CONTRAST” key displays the last test record header stored in FLASH EEPROM. Thereafter each instance of pressing the “PAPER ▼ CONTRAST” key displays the next lower sequential test record header stored in FLASH EEPROM. Pressing the “PAPER ▲ CONTRAST” key displays the next higher sequential test header stored in FLASH EEPROM. Pressing “PAPER ▲ CONTRAST” key when the last test record is displayed will return the LCD display to Figure 49.0
- d. **Action To Perform:** Either option may be selected.

16.17 Restored Record Status Display

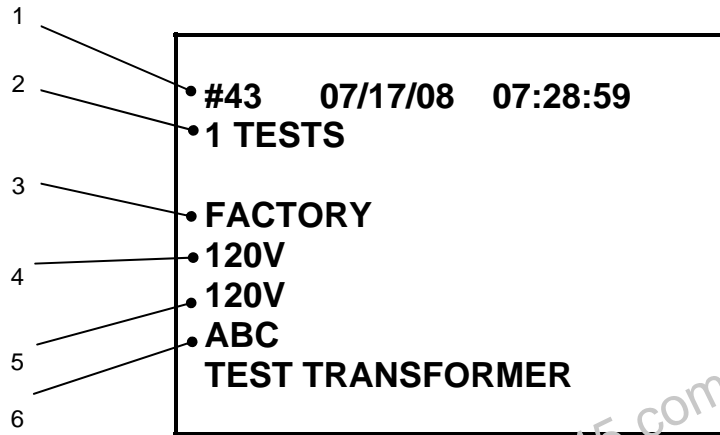

Figure 50.0 Restored Record Status Display

The restored test record header is displayed on the LCD screen.

**NOTE:**

1. The first line of the LCD displays the test record number, date and time of test
2. The second line of the screen displays the number of tests in test record
3. The third line of the screen displays the substation name
4. The fourth line of the screen displays the circuit voltage
5. The fifth of the screen displays the circuit voltage
6. The sixth line of the screen displays the transformer manufacture name

**NOTE:**

After viewing the test record, another test record may be viewed by pressing either the “PAPER ▲ CONTRAST” key or the “PAPER ▼ CONTRAST” key and repeating steps 5 and 6. When all desired test record headers are viewed press “ENTER” to advance to step 8.

16.18 Record Restored Menu

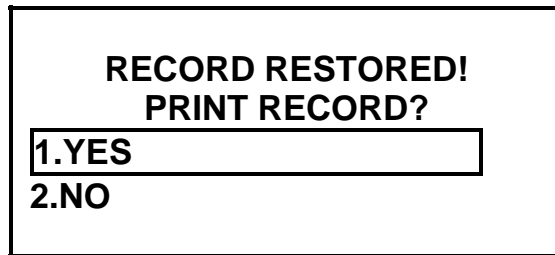

**Figure 51.0 Record Restored Menu**

- a. **Description:** Allows the operator to decide to print or not print the restored record. Deciding not to print the test record allows for viewing of the record on the LCD screen.
- b. **Origin:** Selecting menu option 1 (“YES”) from the “Restore Record Status Display” (Figure 50.0).
- c. **Action Options:** Press key number 1 to select “YES”. Press key number 2 to select the “NO” option. Selection of number 2 may be made by turning the Control Knob and pushing down the Control Knob after number 2 is selected.
- d. **Action To Perform:** Select menu option 1 for this example.

16.19 Print Record Restored Menu

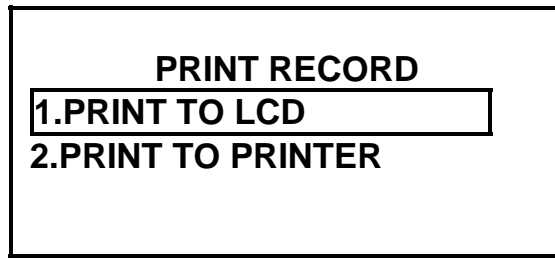

**Figure 52.0 Print Record Restored Menu**

- a. **Description:** Allows the operator to decide to display the restored test record on the LCD or print the restored record.
- b. **Origin:** Selecting menu option 1 (“YES”) from the “Record Restored Menu” (Figure 51.0).
- c. **Action Options:** Press key number 1 to select “PRINT TO LCD” option. Press key number 2 to select “PRINT TO PRINTER” option. Selection of number 2 may be made by turning the Control Knob and pushing down the Control Knob after number 2 is selected.
- d. **Action To Perform:** Select menu option 1 for this example.
- e. **Result of Action:** The restored test record is displayed on the LCD.



16.20 Restored Record Status Displays

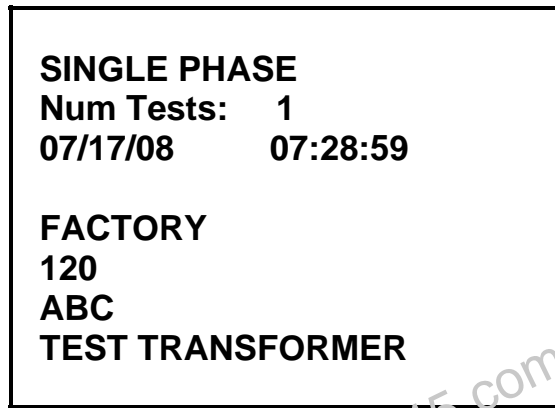

Figure 53.0 Restored Record First Status Display

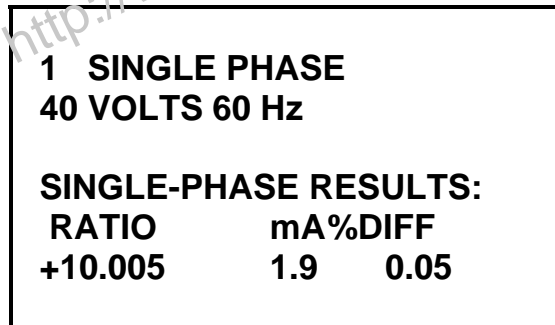

Figure 54.0 Restored Record Second Status Display

- a. **Description:** The test record is displayed on the LCD in two displays.
- b. **Origin:** Selecting menu option 1 (“YES”) from the “Print Record Restored Menu” (Figure 52.0).
- c. **Action To Perform:** Observe the first status display of the test record on the LCD, then press key number 1 or push down the Control Knob. Observe the second status display of the test record on the LCD, then press the “STOP” button.

**16.21 Erase A Test Record Procedure**

The following procedure allows the operator to erase a test record from FLASH EEPROM memory.

**Table 11.0 Erase A Test Record Procedure**

| STEP | DESCRIPTION  | DISPLAY  | ACTION   |
|------|--|--|--|
| 1    | Select "Setup" from the "Main Menu"                              | <b>1.RUN TEST</b><br><b>2.SETUP</b><br><b>3.TEST PLAN</b><br><b>4.DIAGNOSTIC</b><br><b>TIME: 20:15:00</b><br><b>DATE: 07/16/08</b>                   | Press key number 2<br>Selection of 2 may be made by turning the Control Knob. Push down Control Knob after 2 is selected |
| 2    | Select "Save/Restore Record" from the "Setup Menu"               | <b>1.RECORD ID</b><br><b>2.TEST VOLTAGE</b><br><b>3.TEST FREQUENCY</b><br><b>4.PRINT RECORD</b><br><b>5.SAVE/RESTORE RECORD</b><br><b>6.SET TIME</b> | Press key number 5<br>Selection of 5 may be made by turning the Control Knob. Push down Control Knob after 5 is selected |
| 3    | Select "Erase Record" from the "Save/Restore Menu"               | <b>1.RESTORE RECORD</b><br><b>2.SAVE RECORD</b><br><b>3.RECORD DIRECTORY</b><br><b>4.ERASE RECORD</b>  | Press key number 4<br>Selection of 4 may be made by turning the Control Knob. Push down Control Knob after 4 is selected |
| 4    | Select "Erase Single Record Number" from the "Erase Record Menu" | <b>ERASE RECORD</b><br><b>1.ERASE SINGLE RECORD</b><br><b>2.ERASE ALL RECORDS</b><br><b>"STOP" TO EXIT</b>   | Press key number 1 or push down on the Control Knob  |
| 5    | Enter record number to be erased                                 | <b>ERASE RECORD</b><br><b>NUMBER:</b>  | Use keys 0-9 to enter record number<br>(50 was entered)  |
| 6    | Confirm record number  | <b>ERASE RECORD</b><br><b>NUMBER: 50</b>   | Press "ENTER" key or push down Control Knob to confirm<br>(50 was keyed)   |
| 7    | Record erased from FLASH EEPROM                                  | <b>ERASING RECORD</b><br><b>PLEASE WAIT...</b>   | Wait for next display  |
| 8    | Record number erased from FLASH EEPROM confirmation              | <b>RECORD NUMBER 50</b><br><b>ERASED!</b>  | Press any key or push down Control Knob  |
| 9    | Option to choose erasing single or all test records              | <b>ERASE RECORD</b><br><b>1.ERASE SINGLE RECORD</b><br><b>2.ERASE ALL RECORDS</b><br><b>"STOP" TO EXIT</b>   | Press the "STOP" key to return to "Main Menu"  |

16.22 Erase Record Menu

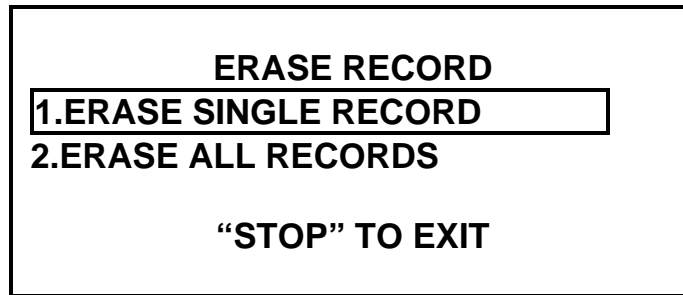

Figure 55.0 Erase Record Menu

- a. **Description:** Allows the operator to erase a single test record, or erase all test records from FLASH EEPROM.
- b. **Origin:** From the “Save/Restore Record Menu” (Figure 39.0) select menu option 4.
- c. **Action Options:** Press key number 1 or push down on the Control Knob to select the “Erase Single Record” option. Press key number 2 to select the “Erase All Records” option. Selection of number 2 may be made by turning the Control Knob and pushing down the Control Knob after number 2 is selected. Press the “STOP” key to return to the “Main Menu”.
- d. **Action To Perform:** Select menu option 1 for this example.

**NOTE:**

*This menu is designed for quick erasing of multiple record numbers without erasing all test records. After erasing a single test record this menu is displayed again for entry of another test record to be erased.*

16.23 Erase Record Status Display



Figure 56.0 Erase Record Status Display

- a. **Description:** Allows the operator to enter the test record number to be erased.
- b. **Origin:** From the “Erase Record Menu” (Figure 55.0) select menu option 1.
- c. **Action Options:** Enter the record number to erase by pressing on the key numbers 0 through 9 and pressing “ENTER” or push down Control Knob to confirm. When an incorrect number is pressed, pressing “CLEAR” before pressing “ENTER” clears the number displayed and allows for another number to be keyed in.
- d. **Action To Perform:** Press key number 5 then key number 0 (i.e., 50 displayed), then press “ENTER” for this example.
- e. **Results Of Action:** After confirming the record number to be erased the following message is displayed:



**NOTES:**

*The following message will display when a record is not found in FLASH EEPROM memory.*

“RECORD NUMBER ##  
NOT FOUND!

where ## is the test record number that was entered  
then “Main Menu” is displayed

*If test record 50 does not exist, then use any record number the operator chooses to erase.*

## 16.24 Record Number Erased Confirmation Status Display

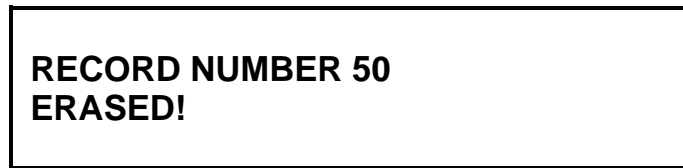

**Figure 57.0 Record Number Erased Status Display**

- a. **Description:** Confirmation of test record erased from FLASH EEPROM memory.
- b. **Origin:** After keying in the test record number to be erased and pressing the “ENTER” key.
- c. **Action To Perform:** Press “STOP” to return the “Main Menu” for this example.

<http://www.51082245.com>

**16.25 Erase All Test Records Procedure**

The following procedure allows the operator to erase all test records from FLASH EEPROM.

**Table 12.0 Erase All Test Records Procedure**

| STEP | DESCRIPTION   | DISPLAY   | ACTION   |
|------|---|---|--|
| 1    | Select "Setup" from the "Main Menu"                     | <b>1.RUN TEST</b><br>2.SETUP<br>3.TEST PLAN<br>4.DIAGNOSTIC<br>TIME: 20:15:00<br>DATE: 07/16/08                   | Press key number 2<br>Selection of 2 may be made by turning the Control Knob. Push down Control Knob after 2 is selected |
| 2    | Select "Save/Restore Record" from the "Setup Menu"      | <b>1.RECORD ID</b><br>2.TEST VOLTAGE<br>3.TEST FREQUENCY<br>4.PRINT RECORD<br>5.SAVE/RESTORE RECORD<br>6.SET TIME | Press key number 5<br>Selection of 5 may be made by turning the Control Knob. Push down Control Knob after 5 is selected |
| 3    | Select "Erase Record" from the "Save/Restore Menu"      | <b>1.RESTORE RECORD</b><br>2.SAVE RECORD<br>3.RECORD DIRECTORY<br>4.ERASE RECORD                                  | Press key number 4<br>Selection of 4 may be made by turning the Control Knob. Push down Control Knob after 4 is selected |
| 4    | Select "Erase All Records" from the "Erase Record Menu" | <b>ERASE RECORD</b><br><b>1.ERASE SINGLE RECORD</b><br>2.ERASE ALL RECORDS<br><br>"STOP" TO EXIT                  | Press key number 2 or push down on the Control Knob  |
| 5    | Confirm that all records are to be erased               | <b>ERASE ALL RECORDS!</b><br>Are you SURE?<br><br>"ENTER" TO CONTINUE.  | Press "ENTER" to confirm   |
| 6    | Records being erased from FLASH EEPROM                  | <b>ERASING RECORDS</b><br><br>PLEASE WAIT...  | Wait for next display  |
| 7    | All records erased from FLASH EEPROM confirmation       | <b>RECORDS ERASED!</b>  | Press any key or push down Control Knob  |
| 9    | Return to "Main Menu"                                   | <b>1.RUN TEST</b><br>2.SETUP<br>3.TEST PLAN<br>4.DIAGNOSTIC<br>TIME: 20:15:00<br>DATE: 07/16/08                   | None   |

16.26 Erase All Records Status Display

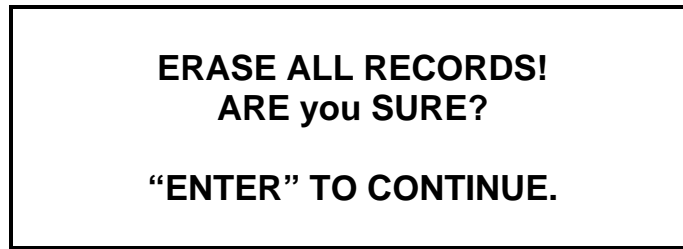

**Figure 58.0 Erase All Records Status Display**

- a. **Description:** Allows the operator to erase all test records from FLASH EEPROM.
- b. **Origin:** From the "Erase Record Menu" (Figure 55.0) select menu option 2.
- c. **Action Options:** Press "ENTER" to confirm to erase all test records. Press "STOP" to abort and return to "Main Menu".
- d. **Action To Perform:** Press "ENTER" to confirm to erase all test records.
- e. **Results of Action:** After confirming to erase all test records the following message is displayed.



## 16.27 Record Number Erased Confirmation Status Display



**Figure 59.0 Records Erased Status Display**

- a. **Description:** Confirmation that all test records have been erased from FLASH EEPROM memory.
- b. **Origin:** After pressing “ENTER” or pushing down Control Knob from the “Erase All Records” status display.
- c. **Action To Perform:** Press any key or push down Control Knob to return the “Main Menu”.

<http://www.51082245.com>



**17.0 Test Plan Options**

**17.1 Load a Test Plan and Test a Transformer Procedure**

Table 13.0 shows the procedure to test a single-phase transformer using a test plan for this example. This procedure may be used for any transformer configuration. Each of the menus is described in detail in the following paragraphs.

**Table 13.0 Load a Test Plan and Test a Transformer Procedure**

| STEP | DESCRIPTION  | DISPLAY  | ACTION   |
|------|--|--|--|
| 1    | Load a test plan that is designed to test a single phase transformer<br><br>Select "Test Plan" from the "Main Menu"                                | <b>1.RUN TEST</b><br><b>2.SETUP</b><br><b>3.TEST PLAN</b><br><b>4.DIAGNOSTIC</b><br><b>TIME: 20:15:00</b><br><b>DATE: 07/16/08</b>                                 | Press key number 3<br>Selection of 3 may be made by turning the Control Knob. Push down Control Knob after 3 is selected |
| 2    | Select "Load Test Plan" from the "Test Plan Menu"  | <b>1.LOAD TEST PLAN</b><br><b>2.UNLOAD TEST PLAN</b><br><b>3.FLAW DIRECTORY</b><br><b>4.PRINT TEST PLAN</b><br><b>5.ERASE TEST PLAN</b><br><b>6.SAVE TEST PLAN</b> | Press key number 1 or push down Control Knob   |
| 3    | "Load Test Plan Status Display"<br>Enter test plan number  | <b>LOAD TEST PLAN</b><br><b>NUMBER:</b>  | Use keys 0 through 9 to enter test plan number   |
| 4    | "Load Test Plan Status Display"<br><br>Confirm test plan number  | <b>LOAD TEST PLAN</b><br><b>NUMBER: 1</b>  | Press "ENTER" key or push down Control Knob<br>(1 was entered)   |
| 5    | Return to "Main Menu"<br><br>Perform test on transformer with test plan  | <b>1.RUN TEST</b><br><b>2.SETUP</b><br><b>3.TEST PLAN</b><br><b>4.DIAGNOSTIC</b><br><b>TIME: 20:15:00</b><br><b>DATE: 07/16/08</b>                                 | Press key number 1 or push down Control Knob   |
| 6    | "Test Plan Loaded Menu"<br>LCD displays test plan loaded in temporary memory to be used to test the transformer<br>Confirm to use test plan loaded | <b>TP #1          Dyn1</b><br><b>TAPS: 1</b><br><br><b>TEST PLAN LOADED</b><br><b>1.CONTINUE</b><br><b>2.UNLOAD TEST PLAN</b>                                      | Press key number 1 or push down Control Knob to continue   |
| 7    | "Test Plan Loaded Status Display"<br><br>LCD displays H and X voltages for test 1  | <b>TAP NUMBER 1</b><br><b>H VTG: 12,000</b><br><b>X VTG: 208</b><br><br><b>"START" to RUN TEST</b>   | Press "START" key to perform test  |

17.1 Load a Test Plan and Test a Transformer Procedure (continued)

Table 13.0 Load a Test Plan and Test a Transformer Procedure (continued)

| STEP | DESCRIPTION   | DISPLAY   | ACTION  |
|------|---|---|---|
| 8    | “Testing In Progress Status Display”  | <b>TEST IN PROGRESS<br/>PLEASE WAIT...</b>  | None  |
| 9    | “Test Results Status Display”<br><br>Observe test results<br>The three phase test results are displayed first, then the phase information for A, B, and C<br><br>The single phase test results are displayed last | <b>SINGLE PHS TEST RSLT:<br/>RATIO mA %DIFF</b><br><b>A+99.985 2.6 0.06 P</b><br><b>B+100.08 1.8 0.16 P</b><br><b>C+99.994 2.4 0.07 P</b><br><br><b>XFMR TYPE: Dyn1</b> | None<br><br>“P” indicates test passed<br><br><i>Note:<br/>Pass and Fail results are shown as “P” or “F” on the LCD.</i> |
| 10   | “Test Results Status Display”<br><br>Go to next LCD display   | <b>SINGLE PHS TEST RSLT:<br/>RATIO mA %DIFF</b><br><b>A+99.985 2.6 0.06 P</b><br><b>B+100.08 1.8 0.16 P</b><br><b>C+99.994 2.4 0.07 P</b><br><br><b>XFMR TYPE: Dyn1</b> | Press any key or push down Control Knob   |
| 11   | “Print Test Results Menu”<br><br>Print test result on built-in printer option   | <b>PRINT TEST RESULTS?</b><br><b>1.YES</b><br><b>2.NO</b>   | Press key number 1 or push down Control Knob  |
| 12   | Select “Column” from the “Print Format Menu”  | <b>PRINT FORMAT</b><br><b>1.COLUMN</b><br><b>2.DETAILED</b>   | Press key number 1 or push down Control Knob  |
| 13   | “Keep This Reading Menu”<br>Store test reading in FLASH EEPROM  | <b>KEEP THIS READING?</b><br><b>1.YES</b><br><b>2.NO</b>  | Press key number 1 or push down Control Knob  |
| 14   | “Test Saved Status Display”   | <b>TEST SAVED</b>   | Press any key or push down Control Knob   |
| 15   | “End of Test Plan Status Display”<br>Last test completed from test plan   | <b>END OF TEST PLAN</b>   | Press any key or push down Control Knob   |
| 16   | “Save This Record Menu”<br><br>Save record in FLASH EEPROM option   | <b>SAVE THIS RECORD?</b><br><b>1.YES</b><br><b>2.NO</b>   | Press key number 1 or push down Control Knob  |

17.1 Load a Test Plan and Test a Transformer Procedure (continued)

Table 13.0 Load A Test Plan And Test Transformer Procedure (continued)

| STEP | DESCRIPTION  | DISPLAY   | ACTION   |
|------|--|---|--|
| 17   | <p>“Record Saved Status Display”</p> <p>Test results saved in FLASH EEPROM to a test record confirmation</p> | <p><b>RECORD NUMBER 60<br/>HAS BEEN SAVED!</b></p>  | <p>Press any key or push down Control Knob to return to “Main Menu”</p> <p>Test record 60 saved for this example</p> |
| 18   | <p>“Main Menu”</p>   | <p><b>1.RUN TEST</b></p> <p><b>2.SETUP</b></p> <p><b>3.TEST PLAN</b></p> <p><b>4.DIAGNOSTIC</b></p> <p><b>TIME: 20:15:00</b></p> <p><b>DATE: 07/16/08</b></p> | <p>None</p>  |

<http://www.51082245.com>

17.2 Test Plan Menu

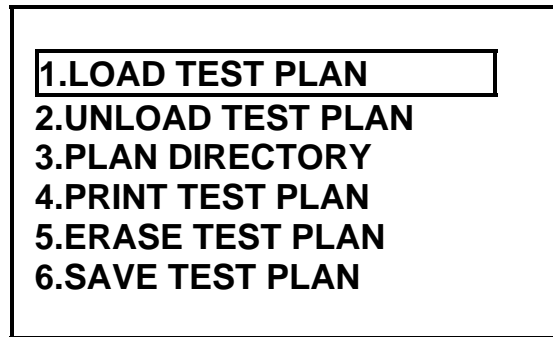
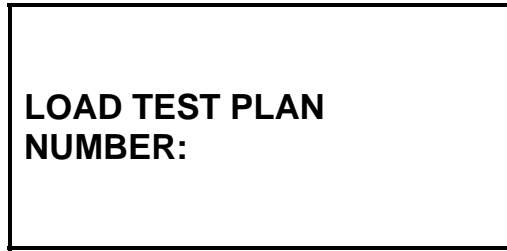

Figure 60.0 Test Plan Menu

- a. **Description:** Allows the operator to select various test plan options.
- b. **Origin:** From the “Main Menu” (Figure 14.0) select menu option 3.
- c. **Action Options:** Press key number 1 or push down on the Control Knob to select the “Load Test Plan” status display. Press key number 2 to select the “Unload Test Plan” status display. Press key number 3 to print the test plan directory. The printing of the test plan directory commences immediately after this selection is made. Press key number 4 to select the “Print Test Plan Menu”. Press key number 5 to select the “Erase Test Plan Menu”. Press key number 6 to select the “Save Test Plan” status display. Selection of 2, 3, 4, 5 or 6 may be made by turning the Control Knob to the desired number and pushing down the Control Knob after it is selected.
- d. **Action To Perform:** Select menu option 1 for this example.

### 17.3 Load Test Plan Number Status Display



**Figure 61.0 Load Test Plan Number Status Display**

- a. **Description:** Allows the operator to enter a test plan number to test a transformer. The pass/fail test requirements for %DIFF are defined in the test plan. This enables the printing of the pass/fail status of the test.
- b. **Origin:** From the “Test Plan Menu” select menu option 1.
- c. **Action Options:** Enter the test plan number to load by pressing on the key numbers 0 through 9 and pressing “ENTER” or push down on the Control Knob to confirm. Press “STOP” to abort and return to “Main Menu”. Press “CLEAR” prior to either of the above actions to enter a different test plan number.
- d. **Action To Perform:** Enter the test plan number 1 for this example by pressing the key number 1 and pressing “ENTER” or push down on the Control Knob to confirm.

**NOTE:**

*If test plan 1 does not exist, then use any test plan number the operator chooses to load.*

17.4 Test Plan Loaded Menu

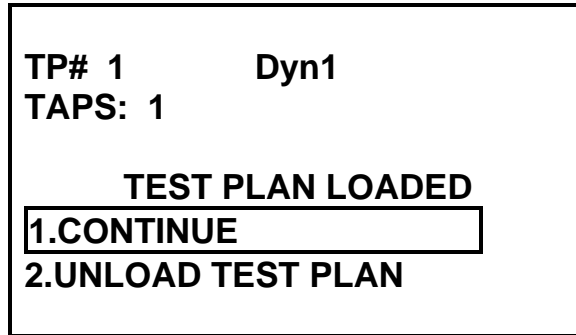

Figure 62.0 Test Plan Loaded Menu

- a. **Description:** Confirms that test plan 1 (i.e., “TP#1”) is loaded in temporary memory. Allows the operator to perform a transformer test using test plan 1 or perform a test with the operator inputting the test parameters (i.e., refer to step 2 of Table 5.0 or step 2 of Table 6.0). The transformer configuration is set by the test plan and for this example it is a Dyn1. The number of tests performed is set by the test plan and referred to as “TAPS” and for this example it is one test.
- b. **Origin:** With a test plan loaded in temporary memory, select menu option 1 from the “Main Menu”.
- c. **Action Options:** Press key number 1 or push down the Control Knob to use test plan. Press key number 2 to perform a test without a test plan. Selection of number 2 may be made by turning the Control Knob and pushing down the Control Knob after number 2 is selected.
- d. **Action To Perform:** Select menu option 1 for this example.

**NOTE:**

Selecting menu option 2 results in the display of the “Transformer Configuration Selection First Menu” (Figure 15.0).

### 17.5 Test Plan Loaded Status Display

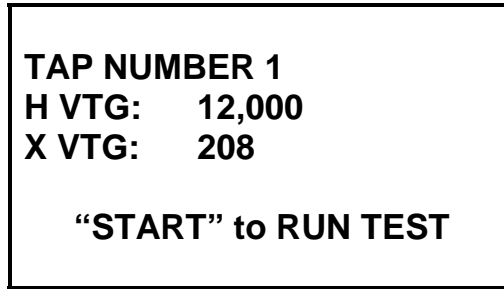

**Figure 63.0 Test Plan Loaded Status Display**

- a. **Description:** Displays H and X voltages set by test plan test number 1 used for testing the transformer.
- b. **Origin:** With a test plan loaded in temporary memory, select menu option 1 from the "Test Plan Loaded Menu".
- c. **Action Options:** Press "START" to perform test number 1. Press "STOP" to abort the test and return to the "Main Menu".
- d. **Action To Perform:** Press "START" to perform test number 1 for this example.

17.6 Test Plan Test Results Status Display

| SINGLE PHS TEST RSLT: |         |        |
|-----------------------|---------|--------|
| RATIO                 | mA%DIFF |        |
| A+99.985              | 2.6     | 0.06 P |
| B+100.08              | 1.8     | 0.16 P |
| C+99.994              | 2.4     | 0.07 P |
| XFMR TYPE: Dyn1       |         |        |

Figure 64.0 Test Plan Test Results Status Display

- a. **Description:** The single phase test results of the measured transformer turns-ratio, excitation current, percentage error, and “PASS/FAIL” (i.e., **P** for pass, **F** for fail) status is displayed for this test. The three phase test results are displayed first, then the phase information for A (i.e., H1-H3, X1-X3 phase difference), B (i.e., H2-H1, X2-X1 phase difference), and C (i.e., H3-H2, X3-X2 phase difference). The single phase test results are displayed last. The single phase differences are: A (H1-H3, X1-X0), B (H2-H1, X2-X0), and C (H3-H2, X3-X0).
- b. **Origin:** This menu is displayed after the TRI-PHASE™ performs a test plan test.
- c. **Action To Perform:** Press any key or push down the Control Knob to advance to the “Print Test Results Menu”.

**NOTE:**

“PASS” or “FAIL” status is shown as “P” or “F” next to the “%DIFF” test result for A, B, and C. The Pass and Fail results are based on the % difference. If the % difference is less than the preset value, the “P”(Pass) is displayed. If the % difference is greater than the preset value, the “F”(Fail) is displayed.



## 17.7 Print Test Plan Test Results

- a. **Description:** The TRI-PHASE™ has the capability to print the test plan test results using the built-in thermal printer.
- b. **Origin:** The “Print Test Results Menu” (Figure 25.0) is displayed after operator presses any key or pushes down on the Control Knob from the “Test Plan Test Result Status Display” (Figure 64.0)
- c. **Action Options:** Refer to the “Print Format Menu” (Figure 26.0). Press key number 1 (“YES”) or push down the Control Knob to print test results. Press key number 2 to advance to “Keep This Reading Menu”. Select number 2 by turning the Control Knob, then pushing down on the Control Knob after number 2 is selected.
- d. **Action To Perform:** Select menu option 1 for this example.

<http://www.51082245.com>

17.8 Test Plan Test Results Printout

| TRANSFORMER TEST RESULTS  |                   |     |        |       |   |
|---|-------------------|-----|--------|-------|---|
| DATE: 07/24/08  | TIME: 15:04:50    |     |        |       |   |
| COMPANY: VANGUARD<br>STATION: FACTORY<br>CIRCUIT: 120<br>MFR: ABC<br>MODEL: TEST TRANSFORMER<br>S/N: 7777777<br>KVA RTG: 500KVA<br>OPERATOR: DAVE |                   |     |        |       |   |
| TEST VOLTAGE = 40 V, 60 Hz  |                   |     |        |       |   |
| TYPE: Dyn1  |                   |     |        |       |   |
|   |                   |     |        |       |   |
| H TAP: _____  | H VOLTAGE: 12,000 |     |        |       |   |
| X TAP: _____  | X VOLTAGE: 208    |     |        |       |   |
| NAME PLATE RATIO: 57.692  |                   |     |        |       |   |
| THREE PHASE TEST RESULTS:   |                   |     |        |       |   |
| PHS   | M_RATIO           | mA  | PHASE  | %DIFF |   |
| A   | 57.755            | 2.5 | 30.02  | 0.11  | P |
| B   | 57.771            | 2.1 | 150.01 | 0.14  | P |
| C   | 57.724            | 3.4 | 270.01 | 0.05  | P |
| SINGLE PHASE TEST RESULTS:  |                   |     |        |       |   |
| PHS   | M_RATIO           | mA  | PHASE  | %DIFF |   |
| A   | +99.985           | 2.6 | 0.09   | 0.06  | P |
| B   | +100.08           | 1.8 | 0.12   | 0.16  | P |
| C   | +99.994           | 2.4 | 0.13   | 0.07  | P |
| DATE: 07/24/08  | TIME: 15:04:50    |     |        |       |   |

PASS/FAIL INDICATION

Figure 65.0 Test Plan Test Results Printout Column Format

**NOTE:**

“PASS” or “FAIL” status is shown as “P” or “F” next to the “%DIFF” printout.  
 The Pass/Fail parameter for this test is %DIFF of 0.5%.

**17.9 Unload a Test Plan Procedure**

The following procedure allows the operator to clear a test plan from the FLASH EEPROM non-volatile memory.

**Table 14.0 Unload A Test Plan Procedure**

| STEP | DESCRIPTION   | DISPLAY  | ACTION   |
|------|---|--|--|
| 1    | Select "Test Plan" from the "Main Menu"             | 1.RUN TEST<br>2.SETUP<br>3.TEST PLAN<br>4.DIAGNOSTIC<br>TIME: 20:15:00<br>DATE: 07/16/08                                 | Press key number 3<br>Selection of 3 may be made by turning the Control Knob. Push down Control Knob after 3 is selected |
| 2    | Select "Unload Test Plan" from the "Test Plan Menu" | 1.LOAD TEST PLAN<br>2.UNLOAD TEST PLAN<br>3.PLAN DIRECTORY<br>4.PRINT TEST PLAN<br>5.ERASE TEST PLAN<br>6.SAVE TEST PLAN | Press key number 2<br>Selection of 2 may be made by turning the Control Knob. Push down Control Knob after 2 is selected |
| 3    | "Test Plan Unloaded" status display                 | TEST PLAN UNLOADED!  | Press any key or push down Control Knob  |
| 4    | Return to "Main Menu"                               | 1.RUN TEST<br>2.SETUP<br>3.TEST PLAN<br>4.DIAGNOSTIC<br>TIME: 20:15:00<br>DATE: 07/16/08                                 | Return to "Main Menu"  |

**NOTE:**

*After initial power-on of the TRI-PHASE™ or at any time that this procedure is performed, the same result occurs.*

**17.10 Print Test Plan Directory Procedure**

The following procedure allows the operator to print the test plan directory stored in FLASH EEPROM non-volatile memory.

**Table 15.0 Print Test Plan Directory Procedure**

| STEP | DESCRIPTION                                       | DISPLAY  | ACTION   |
|------|---|--|--|
| 1    | Select "Test Plan" from the "Main Menu"           | 1.RUN TEST<br>2.SETUP<br>3.TEST PLAN<br>4.DIAGNOSTIC<br>TIME: 20:15:00<br>DATE: 07/16/08                                 | Press key number 3<br>Selection of 3 may be made by turning the Control Knob. Push down Control Knob after 3 is selected |
| 2    | Select "Plan Directory" from the "Test Plan Menu" | 1.LOAD TEST PLAN<br>2.UNLOAD TEST PLAN<br>3.PLAN DIRECTORY<br>4.PRINT TEST PLAN<br>5.ERASE TEST PLAN<br>6.SAVE TEST PLAN | Press key number 3<br>Selection of 3 may be made by turning the Control Knob. Push down Control Knob after 3 is selected |
| 4    | Return to "Main Menu"                             | 1.RUN TEST<br>2.SETUP<br>3.TEST PLAN<br>4.DIAGNOSTIC<br>TIME: 20:15:00<br>DATE: 07/16/08                                 | Return to "Main Menu"  |

**NOTE:**

*The test plan directory is immediately printed after selecting menu option 3.*

### 17.11 Test Plan Directory Print Out

Typical Test Plan Directory is shown in Figure 66.

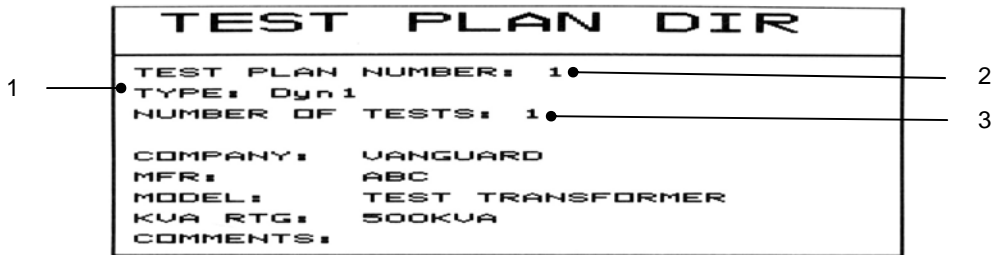

Figure 66.0 Test Plan Directory Print Out

The Test Plan Direct Printout is explained below.

1. Transformer configuration
2. Test plan number
3. Number of tests to perform

**17.12 Print Test Plan Procedure**

Table 16.0 shows the procedure to perform for printing a transformer test plan stored in FLASH EEPROM. Transformer test plans contain the transformer nameplate voltages for each test (i.e., TAP). The calculated ratios (derived from the transformer name plate voltage) are then compared with the measured ratios and the percentage error is calculated (i.e., %DIFF). A test report using the test plan will indicate “PASS” or “FAIL” based on the test plan pass/fail parameters.

**Table 16.0 Print Test Plan Procedure**

| STEP | DESCRIPTION  | DISPLAY  | ACTION   |
|------|--|--|--|
| 1    | Select “Test Plan” from the “Main Menu”            | <b>1.RUN TEST</b><br><b>2.SETUP</b><br><b>3.TEST PLAN</b><br><b>4.DIAGNOSTIC</b><br><b>TIME: 20:15:00</b><br><b>DATE: 07/16/08</b>                                 | Press key number 3<br>Selection of 3 may be made by turning the Control Knob. Push down Control Knob after 3 is selected |
| 2    | Select “Print Test Plan” from the “Test Plan Menu” | <b>1.LOAD TEST PLAN</b><br><b>2.UNLOAD TEST PLAN</b><br><b>3.PLAN DIRECTORY</b><br><b>4.PRINT TEST PLAN</b><br><b>5.ERASE TEST PLAN</b><br><b>6.SAVE TEST PLAN</b> | Press key number 4<br>Selection of 4 may be made by turning the Control Knob. Push down Control Knob after 4 is selected |
| 3    | “Print Test Plan Number” status display            | <b>PRINT TEST PLAN NUMBER:</b>   | Use keys 0 through 9 to enter test plan number   |
| 4    | Confirm test plan number                           | <b>PRINT TEST PLAN NUMBER: 1</b>   | Press “ENTER” key to confirm (1 was entered)   |
| 5    | Return to “Main Menu”                              | <b>1.RUN TEST</b><br><b>2.SETUP</b><br><b>3.TEST PLAN</b><br><b>4.DIAGNOSTIC</b><br><b>TIME: 20:15:00</b><br><b>DATE: 07/16/08</b>                                 | None   |

### 17.13 Print Test Plan Status Display



**Figure 67.0 Print Test Plan Status Display**

- a. **Description:** Allows the operator to enter the test plan to be printed. The test plan header information will be printed.
- b. **Origin:** From the “Test Plan Menu” (Figure 60.0) select menu option 4. Selection of 4 may be made by turning the Control Knob. Push down the Control Knob after option 4 is selected.
- c. **Action Options:** Enter the test plan number and then press “ENTER” or push down the Control Knob.
- d. **Action To Perform:** Press key number 1 then press “ENTER” or push down the Control Knob.

**NOTES:**

*If test plan 1 does not exist, then use any test plan number the operator chooses to print.  
The “Main Menu” is displayed on the LCD after step d is performed.*

### 17.14 Typical Three Phase Dyn1 Test Plan Printout

The test plan test parameters are displayed in Figure 68.0.

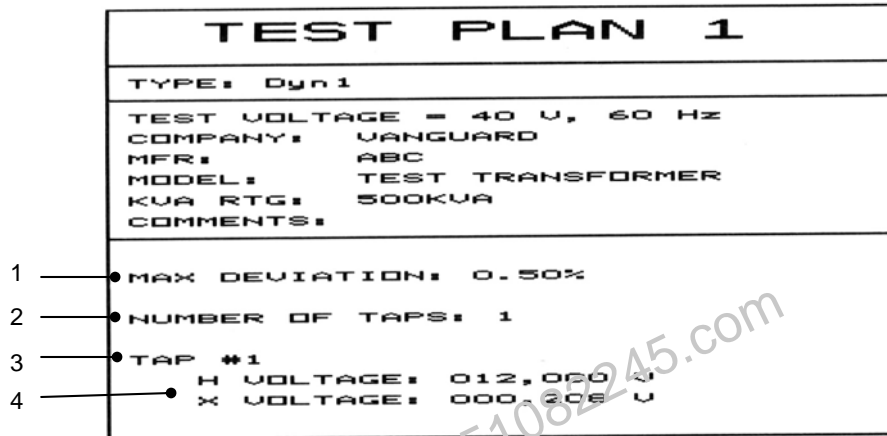

Figure 68.0 Typical Three Phase Dyn1 Test Plan Printout

The test plan direct printout is explained below.

1. *Maximum %Diff limit*
2. *Number of tests (i.e., TAPS)*
3. *Test number 1 heading*
4. *Test number 1 parameters: H and X voltages*



**17.15 Erase A Test Plan Procedure**

The following procedure allows the operator to erase a test plan stored in FLASH EEPROM non-volatile memory.

**Table 17.0 Erase A Test Plan Procedure**

| STEP | DESCRIPTION  | DISPLAY  | ACTION   |
|------|--|--|--|
| 1    | Select "Test Plan" from the "Main Menu"                  | <b>1.RUN TEST</b><br><b>2.SETUP</b><br><b>3.TEST PLAN</b><br><b>4.DIAGNOSTIC</b><br><b>TIME: 20:15:00</b><br><b>DATE: 07/16/08</b>                                 | Press key number 3<br>Selection of 3 may be made by turning the Control Knob. Push down Control Knob after 3 is selected |
| 2    | Select "Erase Test Plan" from the "Setup Menu"           | <b>1.LOAD TEST PLAN</b><br><b>2.UNLOAD TEST PLAN</b><br><b>3.PLAN DIRECTORY</b><br><b>4.PRINT TEST PLAN</b><br><b>5.ERASE TEST PLAN</b><br><b>6.SAVE TEST PLAN</b> | Press key number 5<br>Selection of 5 may be made by turning the Control Knob. Push down Control Knob after 5 is selected |
| 3    | "Erase Test Plan Menu"                                   | <b>ERASE TEST PLAN</b><br><b>1.ERASE SINGLE TEST PLAN</b><br><b>2.ERASE ALL TEST PLANS</b>   | Press key number 1 or push down Control Knob   |
| 4    | "Erase Test Plan Number" status window                   | <b>ERASE TEST PLAN NUMBER:</b>   | Use keys 0-9 to enter test plan number (1 was entered)   |
| 5    | Confirm test plan number                                 | <b>ERASE TEST PLAN NUMBER: 1</b>   | Press "ENTER" key or push down Control Knob to confirm   |
| 6    | Test plan erased from FLASH EEPROM                       | <b>ERASING TEST PLAN PLEASE WAIT...</b>  | Wait for next display  |
| 7    | Test plan number 5 erased from FLASH EEPROM confirmation | <b>TEST PLAN NUMBER 1 ERASED!</b>  | Press any key or push down Control Knob  |
| 8    | Return to "Main Menu"                                    | <b>1.RUN TEST</b><br><b>2.SETUP</b><br><b>3.TEST PLAN</b><br><b>4.DIAGNOSTIC</b><br><b>TIME: 20:15:00</b><br><b>DATE: 07/16/08</b>                                 | None   |

17.16 Erase Test Plan Menu

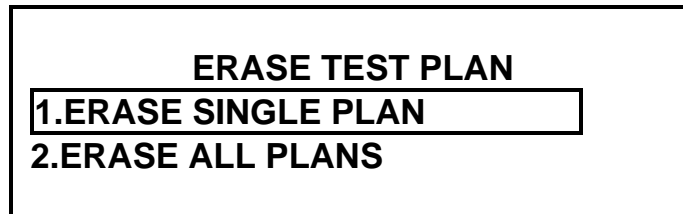

Figure 69.0 Erase Test Plan Menu

- a. **Description:** Allows the operator to erase a single test plan, or erase all test plans from FLASH EEPROM.
- b. **Origin:** From the “Test Plan Menu” (Figure 60.0) select menu option 5.
- c. **Action Options:** Press key number 1 or push down on the Control Knob to select the “Erase Single Plan” option. Press key number 2 to select “Erase All Plans” option. The “Erase All Plans” option may be selected by turning the Control Knob and pushing down the Control Knob after number 2 is selected.
- d. **Action To Perform:** Select menu option 1 for this example.

17.17 Erase Test Plan Status Display



Figure 70.0 Erase Test Plan Status Display

- a. **Description:** Allows the operator to enter the test plan number to be erased.
- b. **Origin:** From the “Erase Test Plan Menu” (Figure 69.0) select menu option 1.
- c. **Action Options:** Enter the test plan number to erase by pressing on keys number 0 through 9 and pressing “ENTER” or pushing down the Control Knob to confirm. When an incorrect number is pressed, pressing “CLEAR” before pressing “ENTER” clears the number displayed and allows for another number to be keyed.
- d. **Action To Perform:** Press key number 1 for this example then press “ENTER”.
- e. **Results of Action Performed:** After pressing “ENTER” to confirm the test plan number to be erased the following message is displayed.



**NOTES:**

*The following message will be displayed when a test plan is not found in FLASH EEPROM memory.*

“TEST PLAN NUMBER ##  
NOT FOUND!

where ## is the test plan number that was entered  
Press any key or push down Control Knob to return the “Main Menu”

*If test plan 1 does not exist, then use any test plan number the operator chooses to erase.*

17.18 Test Plan Number Erased Confirmation Status Display

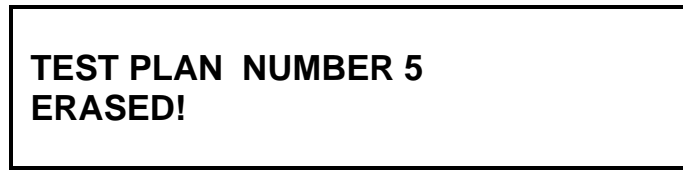

**Figure 71.0 Test Plan Number Erased Status Display**

- a. **Description:** Confirmation of test plan number erased from FLASH EEPROM memory.
- b. **Origin:** After confirming the test plan to be erased.
- c. **Action To Perform:** Press any key or push down the Control Knob to return to the “Main Menu”.

<http://www.51082245.com>

**18.0 Entering Test Record Identification Information Procedure**

The following procedure allows the operator to enter transformer identification information for the test record ID. This information is printed on each test record printout.

**Table 18.0 Entering Test Record Identification Information Procedure**

| STEP | DESCRIPTION                     | DISPLAY  | ACTION   |
|------|---------------------------------|--|--|
| 1    | Select "Setup" from "Main Menu" | <b>1.RUN TEST</b><br><b>2.SETUP</b><br><b>3.TEST PLAN</b><br><b>4.DIAGNOSTIC</b><br><b>TIME: 20:15:00</b><br><b>DATE: 07/16/08</b>                   | Press key number 2<br>Selection of 2 may be made by turning the Control Knob. Push down Control Knob after 2 is selected |
| 2    | Select "Record ID"              | <b>1.RECORD ID</b><br><b>2.TEST VOLTAGE</b><br><b>3.TEST FREQUENCY</b><br><b>4.PRINT RECORD</b><br><b>5.SAVE/RESTORE RECORD</b><br><b>6.SET TIME</b> | Press key number 1 or push down Control Knob   |
| 3    | Enter Company name              | <b>COMPANY:</b><br><br><b>VANGUARD INSTRUMENTS</b><br><br>↑/↓ TO POSITION<br>"ENTER" TO ACCEPT   | Use the alpha-numeric keys to enter Company name*<br>Press "ENTER" key to confirm<br>(Vanguard Instruments entered)      |
| 4    | Enter Substation name           | <b>STATION:</b><br><br><b>FACTORY</b><br><br>↑/↓ TO POSITION<br>"ENTER" TO ACCEPT  | Use the alpha-numeric keys to enter Substation name*<br>Press "ENTER" key to confirm<br>(Factory entered)                |
| 5    | Enter Circuit name              | <b>CIRCUIT:</b><br><br><b>120V</b><br><br>↑/↓ TO POSITION<br>"ENTER" TO ACCEPT   | Use the alpha-numeric keys to enter Circuit name*<br>Press "ENTER" key to confirm<br>(120V entered)                      |
| 6    | Enter Manufacturer name         | <b>MANUFACTURER:</b><br><br><b>ABC</b><br><br>↑/↓ TO POSITION<br>"ENTER" TO ACCEPT   | Use the alpha-numeric keys to enter transformer manufacturer name*<br>Press "ENTER" key to confirm<br>(ABC entered)      |

\*see note at end of table

**Table 18.0 Enter Transformer Identification for Test Record Procedure (continued)**

| STEP | DESCRIPTION                     | DISPLAY  | ACTION   |
|------|---------------------------------|--|--|
| 7    | Enter Transformer Model         | <b>MODEL:</b><br><b>TEST TRANSFORMER</b><br>↑/↓ TO POSITION<br>“ENTER” TO ACCEPT   | Use the alpha-numeric keys to enter Transformer model*<br>Press “ENTER” key to confirm<br>(Single Phase entered)               |
| 8    | Enter Transformer Serial Number | <b>SERIAL NUMBER:</b><br><b>7777777</b><br>↑/↓ TO POSITION<br>“ENTER” TO ACCEPT  | Use the alpha-numeric keys to enter Transformer serial number*<br>Press “ENTER” key to confirm<br>(1234567890 entered)         |
| 9    | Enter Transformer KVA rating    | <b>KVA RATING:</b><br><b>500KVA</b><br>↑/↓ TO POSITION<br>“ENTER” TO ACCEPT  | Use the alpha-numeric keys to enter Transformer KVA rating*<br>Press “ENTER” key to confirm<br>(500 entered)                   |
| 10   | Enter Operator name             | <b>OPERATOR:</b><br><b>DAVE</b><br>↑/↓ TO POSITION<br>“ENTER” TO ACCEPT  | Use the alpha-numeric keys to enter the Operator name performing test*<br>Press “ENTER” key to confirm<br>(Hai Nguyen entered) |
| 11   | Return to “Main Menu”           | <b>1.RUN TEST</b><br><b>2.SETUP</b><br><b>3.TEST PLAN</b><br><b>4.DIAGNOSTIC</b><br><b>TIME: 20:15:00</b><br><b>DATE: 07/16/08</b> | None   |

\*see note

**NOTE:**

*Press the ▲ (moves cursor to right) and/or ▼ (moves cursor to left) keys to position the cursor in the proper location in the line.*

*Successively pressing a key on the keypad will cycle through the characters on the key’s legend and display it at the cursor location.*

**19.0 Test Voltage Selection Procedure**

Table 19.0 shows the procedure to perform in order to select a transformer test voltage. Refer to section 19.1 for a description of the available transformer test voltages.

**Table 19.0 Transformer Test Voltage Selection Procedure**

| STEP | DESCRIPTION                                 | DISPLAY  | ACTION   |
|------|---|--|--|
| 1    | Select "Setup" from "Main Menu"             | 1.RUN TEST<br>2.SETUP<br>3.TEST PLAN<br>4.DIAGNOSTIC<br>TIME: 20:15:00<br>DATE: 07/16/08                   | Press key number 2<br>Selection of 2 may be made by turning the Control Knob. Push down Control Knob after 2 is selected |
| 2    | Select "Test Voltage" from the "Setup Menu" | 1.RECORD ID<br>2.TEST VOLTAGE<br>3.TEST FREQUENCY<br>4.PRINT RECORD<br>5.SAVE/RESTORE RECORD<br>6.SET TIME | Press key number 2<br>Selection of 2 may be made by turning the Control Knob. Push down Control Knob after 2 is selected |
| 3    | Select "8 Volts"                            | 1. 8 Volts<br>2. 40 Volts<br>3. 100 Volts  | Press key number 1 or push down Control Knob<br>(8 volts is selected)  |
| 4    | Confirm test voltage                        | 8 VOLTS SET  | Press any key or push down Control Knob  |
| 5    | Return to "Main Menu"                       | 1.RUN TEST<br>2.SETUP<br>3.TEST PLAN<br>4.DIAGNOSTIC<br>TIME: 20:15:00<br>DATE: 07/16/08                   | None   |

### 19.1 Test Voltage Selection

The TRI-PHASE™ has the capability to output three different test voltages of 8Vac, 40Vac, or 100Vac. The test voltages are generated by an internal oscillator.

- The 8Vac test voltage is for testing transformers which require low test voltages, such as metering Current Transformers (CT). Higher test voltages may drive the CT's into saturation giving invalid results.
- The 40Vac test voltage is recommended for testing power transformers. When the TRI-PHASE™ is powered-on, the transformer test voltage is set to 40Vac.
- The 100Vac is recommended for testing power transformers in noisy environments.

The test voltages are selected either when using the “Computer Interface Mode” or from the keypad.

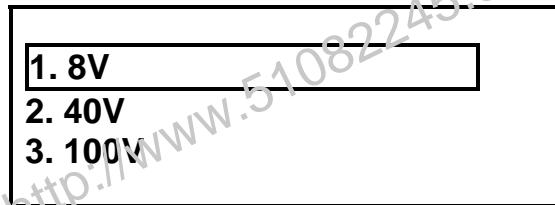

**Figure 72.0 Test Voltage Selection Menu**

- Description:** The operator selects the desired test voltage (8Vac, 40Vac, and 100Vac). The default voltage of 40V is set at power-on.
- Origin:** From “Setup Menu” select menu option 2. Selection of 2 may be made by turning the Control Knob. Push down the Control Knob after 2 is selected.
- Action Options:** Press key number 1 or push down the Control Knob to select 8Vac. Press key number 2 to select 40V. Selection of number 2 may be made by turning the Control Knob. Push down the Control Knob after number 2 is selected. Press key number 3 to select 100V. Selection of number 3 may be made by turning the Control Knob. Push down the Control Knob after number 3 is selected.
- Action To Perform:** Select menu option 1 for this example.

**NOTE:**

*After a test voltage is selected the TRI-PHASE™ will continue to use the test voltage until another test voltage is selected or the unit is powered-down.*



**20.0 Test Frequency Selection Procedure**

Table 20.0 shows the procedure to perform in order to select a transformer test frequency. Refer to section 20.1 for a description of the available transformer test frequencies.

**Table 20.0 Transformer Test Frequency Selection Procedure**

| STEP | DESCRIPTION                                 | DISPLAY  | ACTION   |
|------|---|--|--|
| 1    | Select "Setup" from "Main Menu"             | 1.RUN TEST<br>2.SETUP<br>3.TEST PLAN<br>4.DIAGNOSTIC<br>TIME: 20:15:00<br>DATE: 07/16/08                   | Press key number 2<br>Selection of 2 may be made by turning the Control Knob. Push down Control Knob after 2 is selected |
| 2    | Select "Test Voltage" from the "Setup Menu" | 1.RECORD ID<br>2.TEST VOLTAGE<br>3.TEST FREQUENCY<br>3.PRINT RECORD<br>4.SAVE/RESTORE RECORD<br>5.SET TIME | Press key number 3<br>Selection of 3 may be made by turning the Control Knob. Push down Control Knob after 3 is selected |
| 3    | Select "8 Volts"                            | 1. 60 Hz<br>2. 50 Hz   | Press key number 1 or push down Control Knob<br>(60 Hz is selected)  |
| 4    | Confirm test voltage                        | 60 Hz SET  | Press any key or push down Control Knob  |
| 5    | Return to "Main Menu"                       | 1.RUN TEST<br>2.SETUP<br>3.TEST PLAN<br>4.DIAGNOSTIC<br>TIME: 20:15:00<br>DATE: 07/16/08                   | None   |

### 20.1 Test Frequency Selection

The TRI-PHASE™ has the capability to output two different test frequencies of 50 Hz or 60 Hz. The test frequencies are generated by an internal oscillator. The test frequencies are selected either when using the “Computer Interface Mode” or from the keypad.

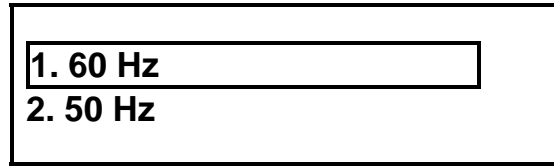

**Figure 73.0 Test Frequency Selection Menu**

- a. **Description:** The operator selects the desired test frequency (50 Hz or 60 Hz). The default frequency of 60 Hz is set at power-on.
- b. **Origin:** From “Setup Menu” select menu option 3. Selection of 3 may be made by turning the Control Knob. Push down the Control Knob after 3 is selected.
- c. **Action Options:** Press key 1 or push down the Control Knob to select 60 Hz. Press key number 2 to select 50 Hz. Selection of number 2 may be made by turning the Control Knob. Push down the Control Knob after number 2 is selected.
- d. **Action To Perform:** Select menu option 1 for this example.

**NOTE:**

*After a test frequency is selected, the TRI-PHASE™ will continue to use it until another test frequency is selected or the unit is powered-down.*

## 21.0 Change Date And Time Procedure

The following procedure allows the operator to change the TRI-PHASE™ date and time.

**Table 21.0 Change Date and Time Procedure**

| STEP | DESCRIPTION   | DISPLAY   | ACTION   |
|------|---|---|--|
| 1    | Select "Setup Menu"   | <div style="border: 1px solid black; padding: 2px;">1.RUN TEST</div> 2.SETUP<br>3.TEST PLAN<br>4.DIAGNOSTIC<br>TIME: 20:15:00<br>DATE: 07/16/08                   | Press key number 2<br>Selection of 2 may be made by turning the Control Knob. Push down Control Knob after 2 is selected |
| 2    | Select "Set Time Menu"  | <div style="border: 1px solid black; padding: 2px;">1.RECORD ID</div> 2.TEST VOLTAGE<br>3.TEST FREQUENCY<br>4.PRINT RECORD<br>5.SAVE/RESTORE RECORD<br>6.SET TIME | Press key number 6<br>Selection of 6 may be made by turning the Control Knob. Push down Control Knob after 6 is selected |
| 3    | "Enter Date" status display<br>Enter date using the MM-DD-YY format | ENTER DATE<br><br>MM-DD-YY  | Use key numbers 0 through 9 for data entry   |
| 4    | "Enter Time" status display<br>Enter time using the HH-MM-SS format | ENTER TIME<br><br>HH-MM-SS  | Use key numbers 0 through 9 for data entry   |
| 5    | "Main Menu"   | <div style="border: 1px solid black; padding: 2px;">1.RUN TEST</div> 2.SETUP<br>3.TEST PLAN<br>4.DIAGNOSTIC<br>TIME: 20:15:00<br>DATE: 07/16/08                   | Return to "Main Menu"  |

**NOTES:**

*The "Enter Time" status is displayed immediately after entering the last digit of the year from the "Enter Date" status display.*

*The "Main Menu" is displayed immediately after entering the last digit of the seconds from the "Enter Time" status display.*

## 21.1 Enter Date Status Display



**Figure 74.0 Enter Date Status Display**

- a. **Description:** The date is stored in a battery powered volatile memory. The time and date are displayed on the lower portion of the LCD when the TRI-PHASE™ is operational.
- b. **Origin:** From the “Start Up Menu”, press key number 6. Selection of number 6 may be made by turning the Control Knob. Push down the Control Knob after number 6 is selected.
- c. **Action To Perform:** Enter month, day, year using key numbers 0 through 9. The date format is MM-DD-YY.

**NOTES:**

*The “Enter Time” status is displayed immediately after entering the last digit of the year from the “Enter Date” status display.*

*“CLEAR” cannot be used to revise incorrect data entry.  
If incorrect data entry is made, press the “STOP” key and start over.*

## 21.2 Enter Time Status Display



**Figure 75.0 Enter Time Status Display**

- a. **Description:** The time is stored in a battery powered volatile memory. The time and date are displayed on the lower portion of the LCD when the TRI-PHASE™ is operational.
- b. **Origin:** Immediately after entering the last digit of the date from step c of section 21.1.
- c. **Action To Perform:** Immediately after entering the last digit of the date, enter hours, minutes, and seconds using key numbers 0 through 9. The 24 hour time format is HH-MM-SS.

**NOTES:**

*The “Main Menu” is displayed immediately after entering the last digit of the seconds from the “Enter Time” status display.*

*“CLEAR” cannot be used to revise incorrect data entry.  
If incorrect data entry is made, press the “STOP” key and start over.*

**22.0 H And X Cable Diagnostic Test Procedure**

The following procedure allows the operator to perform diagnostics on the TRI-PHASE™ H and X cables.

**Table 22.0 H And X Cable Diagnostic Test Procedure**

| STEP | DESCRIPTION                                    | DISPLAY  | ACTION   |
|------|--|--|--|
| 1    | Select "Diagnostic" from "Main Menu"           | 1.RUN TEST<br>2.SETUP<br>3.TEST PLAN<br>4.DIAGNOSTIC<br>TIME: 20:15:00<br>DATE: 07/16/08 | Press key number 4<br>Selection of 4 may be made by turning the Control Knob. Push down Control Knob after 4 is selected |
| 2    | Select "Cable Test" from the "Diagnostic Menu" | DIAGNOSTIC<br>1.CABLE TEST<br>2.VERIFICATION TEST  | Press key number 1 or push down Control Knob   |
| 3    | Connect cables as instructed in display        | CABLE TEST<br>CONNECT: H0-X0, H1-X1<br>H2-X2, H3-X3<br>"ENTER" TO CONTINUE               | Press "ENTER" key after connecting cables  |
| 4    | Observe test results                           | CABLE TEST<br>H0-X0, H1-X1: OK<br>H0-X0, H2-X2: OK<br>H0-X0, H3-X3: OK                   | Press any key to or push down Control Knob return to "Main Menu"   |
|      | "Main Menu"                                    | 1.RUN TEST<br>2.SETUP<br>3.TEST PLAN<br>4.DIAGNOSTIC<br>TIME: 20:15:00<br>DATE: 07/16/08 | None   |

**NOTE:**

*A failed diagnostic on the cable test will display "NOT OK".*

**23.0 TRI-PHASE™ Verification Test Procedure**

The following procedure allows the operator to perform a verification test on the TRI-PHASE™ electronics.

**Table 23.0 TRI-PHASE™ Verification Test Procedure**

| STEP | DESCRIPTION   | DISPLAY  | ACTION   |
|------|---|--|--|
| 1    | Select "Diagnostic" from the "Main Menu"                      | 1.RUN TEST<br>2.SETUP<br>3.TEST PLAN<br>4.DIAGNOSTIC<br>TIME: 20:15:00<br>DATE: 07/16/08 | Press key number 4<br>Selection of 4 may be made by turning the Control Knob. Push down Control Knob after 4 is selected |
| 2    | Select "Verification Test" from the "Diagnostic Menu"         | DIAGNOSTIC<br>1.CABLE TEST<br>2.VERIFICATION TEST  | Press key number 2<br>Selection of 2 may be made by turning the Control Knob. Push down Control Knob after 2 is selected |
| 3    | Connect cables as instructed in display                       | VERIFICATION TEST<br>CONNECT: H0-X0, H1-X1<br>H2-X2, H3-X3<br>"ENTER" TO CONTINUE        | Press "ENTER" key after connecting cables  |
| 4    | Test is performed on Delta to Delta transformer configuration | TEST RESULTS<br>RATIO mA %DIFF<br>+1.0000 0001<br>+1.0000 0001<br>+1.0000 0001           | Press "ENTER" key to advance   |
| 5    | Test is performed on Y to Y transformer configuration         | TEST RESULTS<br>RATIO mA %DIFF<br>+1.0000 0001<br>+1.0000 0001<br>+1.0000 0001           | Press "ENTER" key to advance   |
| 6    | Return to "Main Menu"   | TEST COMPLETE  | Press any key to or push down Control Knob   |
|      | "Main Menu"   | 1.RUN TEST<br>2.SETUP<br>3.TEST PLAN<br>4.DIAGNOSTIC<br>TIME: 20:15:00<br>DATE: 07/16/08 | None   |

**NOTE:**

*A ratio reading of 1.0000 ±0.1% is expected for all the test combinations for the TRI-PHASE™. Disregard the excitation current reading in this test.*

## 24.0 Load Tap Changer

A built-in Load Tap Changer (LTC) controller provides the capability to raise or lower the LTC tap position from the TRI-PHASE™ front panel. The LTC interface cable has four connectors that are color coded. The two green cable connectors are labeled “RAISE”, and two white cable connectors are labeled “LOWER”.

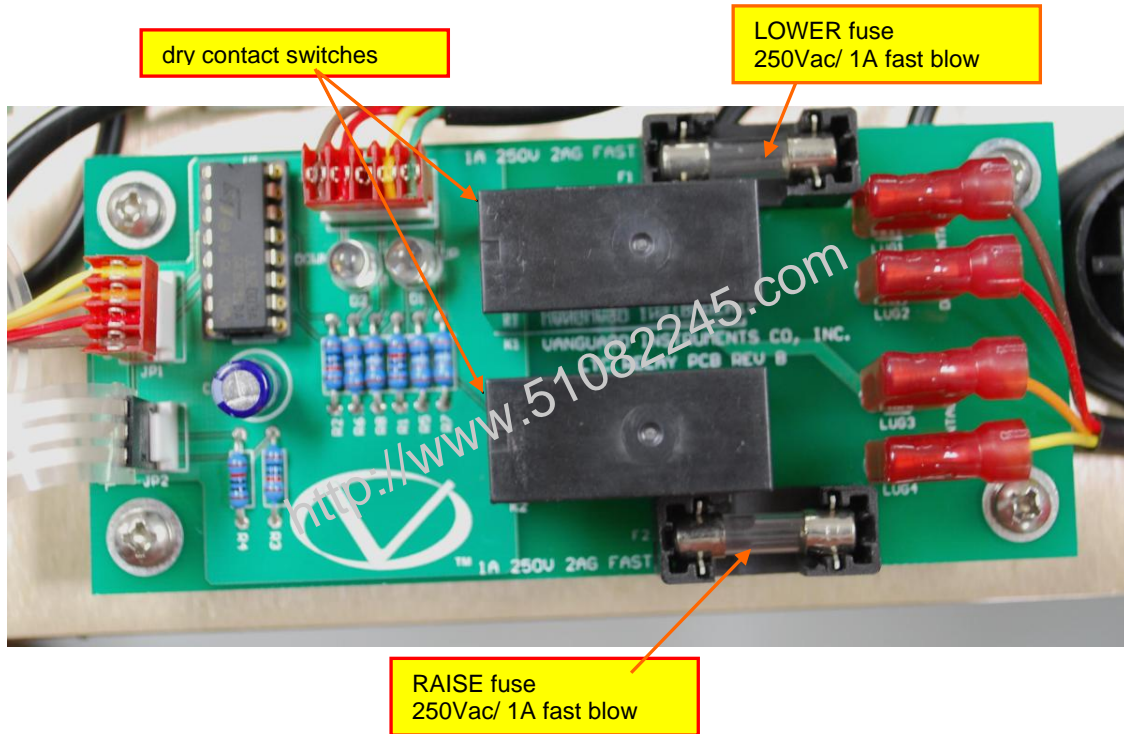

**Figure 76.0 Load Tap Changer Controller**

The components of the LTC that the operator needs to be aware of are:

- Two sets of dry contact switches
- Two 1A/250Vac fuses (5 X 20mm fast-acting type, 217 000 series P/N 217001)
- The RAISE switch electrically closes the raise contact
- The LOWER switch electrically closes the lower contact



## 25.0 USB FLASH Thumb Drive

With the USB FLASH thumb drive inserted many of the operational menus described in this manual will contain an extra option to select the thumb drive. When this option is selected, the submenus will allow for selection of the internal FLASH EEPROM memory or the thumb drive FLASH memory. The following paragraphs describe each menu that has these added options and their related status displays.

### 25.1 Save/Restore Record With Thumb Drive Menu

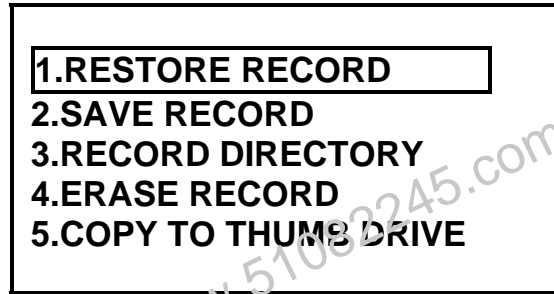

Figure 77.0 Save/Restore Record With Thumb Drive Menu

- a. **Description:** Allows the operator to restore a test record, save a test record, print a directory of test records, erase a single test record or all test records, or copy test record(s) to the thumb drive.
- b. **Origin:** From the “Setup Menu” (Figure 38.0) select menu option 4.
- c. **Action Options:** Press key number 1 or push down the Control Knob to select the “Restore Record Menu”. Press key number 2 to select the “Save Record Menu”. Press key number 3 to select the “Record Directory Menu”. Press key number 4 to select the “Erase Record Menu”. Press key number 5 to select the “Copy To Thumb Drive” record menu. Selection of 2, 3, 4, or 5 may be made by turning the Control Knob to the desired number and pushing down the Control Knob after it is selected.

**NOTE:**

*When test record(s) is/are saved to or copied to the thumb drive a new folder is added to the root directory of the thumb drive. The name of this folder is VANGUARD. The test record(s) that were saved or copied are contained in this new folder in a sub-folder named TRI-PHS.*

## 25.2 Copy Record To Thumb Drive Menu



**Figure 78.0 Copy Record To Thumb Drive Menu**

- a. **Description:** Allows the operator to copy a single record to the thumb drive or copy all records to thumb drive.
- b. **Origin:** From the “Save/Restore Record With Thumb Drive Menu” (Figure 77.0) select menu option 5.
- c. **Action Options:** Press key number 1 or push down the Control Knob to select the “Copy Single Record” status displays. Press key number 2 to select the “Copy All Records” status displays. Selection of number 2 may be made by turning the Control Knob to 2 and pushing down the Control Knob after number 2 is selected.

25.3 Copy Single Record To Thumb Drive Status Displays

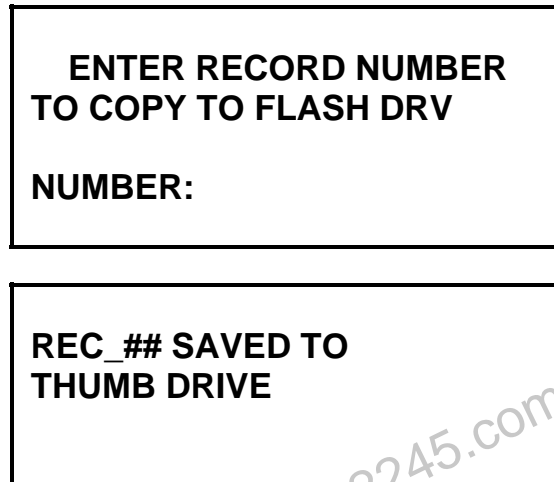

Figure 79.0 Copy Single Record To Thumb Drive Status Displays

- a. **Description:** Allows the operator to copy a single record to thumb drive.
- b. **Origin:** From the “Copy Record To Thumb Drive Test Menu” (Figure 78.0) select menu option 1.
- c. **Action Options:** Enter the record number to copy to the thumb drive using key numbers 0 through 9. Press the “CLEAR” key to enter another number. Press the “ENTER” key or push down the Control Knob to confirm.
- d. **Status Displays:** The top status display is for entering the record number. The bottom status display confirms that the record has been saved to thumb drive.

## 25.4 Copy All Records To Thumb Drive Status Displays

The following status displays when menu option 2 of “Copy To Thumb Drive Test Record Menu” has been selected.



**Figure 80.0 Copy All Records To Thumb Drive Status Displays**

- a. **Description:** Status displays while each record is saved to thumb drive. The record numbers appear in sequential order.
- b. **Origin:** After confirming to copy all records to thumb drive from the “Copy Record To Thumb Drive Menu” (Figure 78.0).
- c. **Action Options:** Press any key or push down the Control Knob.
- d. **Status Displays:** The top status displays, in sequential order, each record number that is saved. The bottom status display confirms that all records have been transferred (i.e., saved) to thumb drive.

25.5 Test Plan With Thumb Drive Menu

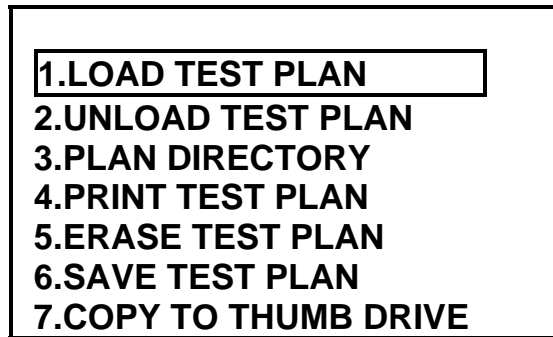

Figure 81.0 Test Plan With Thumb Drive Menu

- a. **Description:** Allows the operator to select various test plan operations.
- b. **Origin:** From the “Main Menu” (Figure 14.0) press key number 3. Selection of number 3 may be made by turning the Control Knob. Push down the Control Knob after number 3 is selected.
- c. **Action Options:** Press key number 1 or push down on the Control Knob to select the “Load Test Plan” status display. Press key number 2 to select the “Unload Test Plan” status display. Press key number 3 to print the test plan directory. The printing of the test plan directory commences immediately after this selection is made. Press key number 4 to select the “Print Test Plan Menu”. Press key number 5 to select the “Erase Test Plan Menu”. Press key number 6 to select the “Save Test Plan” status display. Press key number 7 to select “Copy To Thumb Drive” status display. Selection of 2, 3, 4, 5, 6 or 7 may be made by turning the Control Knob to the desired number and pushing down the Control Knob after it is selected.

**NOTE:**

*When test plan(s) is/are saved to or copied to the thumb drive a new folder is added to the root directory of the thumb drive. The name of this folder is VANGUARD. The test plan(s) that were saved or copied are contained in this new folder in a sub-folder named TRI-PHS.*

## 25.6 Copy Test Plan To Thumb Drive Status Display

**ENTER TP NUMBER  
TO COPY TO FLASH DRV**

**TP NUMBER:**

**Figure 82.0 Copy Test Plan To Thumb Drive Status Display**

- a. **Description:** Allows the operator to copy a test plan from internal memory to the thumb drive.
- b. **Origin:** This menu is displayed after the operator selects menu option 7 (“Copy To Thumb Drive”) from the “Test Plan With Thumb Drive Menu” (Figure 81.0).
- c. **Action Options:** Enter the test plan to copy from the thumb drive using key numbers 0 through 9. Press the “CLEAR” key to enter another number. Press the “ENTER” key or push down the Control Knob to confirm.

25.7 Test Plan Saved To Thumb Drive Confirmation Status Displays



Figure 83.0 Test Plan Saved To Thumb Drive Confirmation Status Displays

- a. **Description:** Confirmation of a test plan copied to thumb drive from internal memory.
- b. **Origin:** This menu is displayed after the operator selects the test plan number from the “Copy Test Plan To Thumb Drive” (Figure 82.0) status display.
- c. **Action Options:** Press any key or push down the Control Knob.
- d. **Status Displays:** The top status displays first while the test plan is copied from internal memory to the thumb drive. The bottom confirmation status displays the test plan number with the corresponding thumb drive test plan number.

## 25.8 Load Test Plan With Thumb Drive Menu



**Figure 84.0 Load Test Plan Number With Thumb Drive Menu**

- a. **Description:** Allows the operator to load a test plan from either the internal memory or from the thumb drive.
- b. **Origin:** This menu is displayed after the operator selects menu option 1 (“Load Test Plan”) from the “Test Plan With Thumb Drive Menu” (Figure 84.0).
- c. **Action Options:** To load a test plan from internal memory press key number 1 or push down the Control Knob. To load a test plan from the thumb drive press key number 2. Selection of number 2 may be made by turning the Control Knob to 2 and pushing down the Control Knob after number 2 is selected.



25.9 Load Thumb Drive Test Plan Status Displays

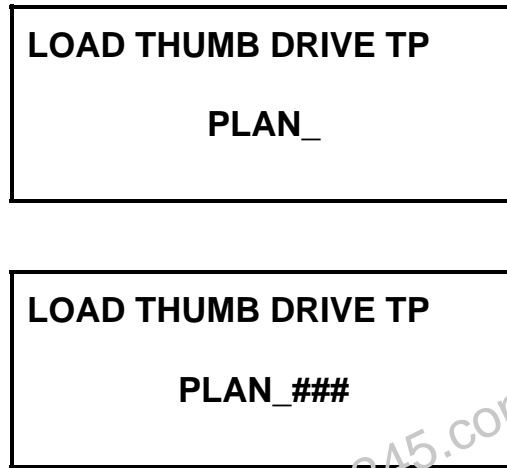

Figure 85.0 Load Thumb Drive Test Plan Status Displays

- a. **Description:** Allows the operator to load a test plan from the thumb drive.
- b. **Origin:** This menu is displayed after the operator selects number 2 (“Thumb Drive”) from the “Load Test Plan Number With Thumb Drive Menu” (Figure 84.0).
- c. **Action Options:** Enter the test plan to load from the thumb drive into internal memory using key numbers 0 through 9. Press the “CLEAR” key to enter another number. Press the “ENTER” key or push down the Control Knob to confirm.
- d. **Status Displays:** The top status displays first. The bottom status display indicates the test plan number entered by the operator.

## 25.10 Print Test Plan Directory With Thumb Drive Menu



1.INTERNAL DIRECTORY  
2.THUMB DRIVE DIR

**Figure 86.0 Print Test Plan Directory With Thumb Drive Menu**

- a. **Description:** Allows the operator to print a test plan directory from the internal memory or from the thumb drive.
- b. **Origin:** This menu is displayed after the operator selects menu option 3 (“Plan Directory”) from the “Test Plan With Thumb Drive Menu” (Figure 84.0).
- c. **Action Options:** Press key number 1 or push down the Control Knob to select Internal (test plan) Directory. To select the thumb drive test plan directory, press key number 2. Selection of number 2 may be made by turning the Control Knob to 2 and pushing down the Control Knob after number 2 is selected.

**NOTE:**

*The test plan directory is immediately printed after selecting either menu option.*

## 25.11 Print Test Plan With Thumb Drive Menu

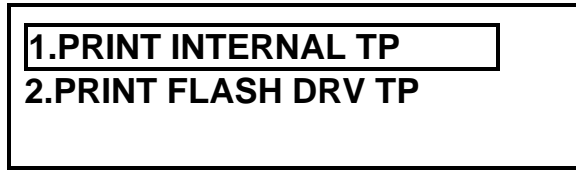

**Figure 87.0 Print Test Plan With Thumb Drive Menu**

- a. **Description:** Allows the operator to print a test plan from either the internal memory or from the thumb drive.
- b. **Origin:** This menu is displayed after the operator selects menu 4 (“Print Test Plan”) from the “Test Plan With Thumb Drive Menu” (Figure 31.0).
- c. **Action Options:** Press key number 1 or push down the Control Knob to select an internal test plan. To select a thumb drive test plan, press key number 2. Selection of number 2 may be made by turning the Control Knob to 2 and pushing down the Control Knob after number 2 is selected.

25.12 Print Thumb Drive Test Plan Status Displays

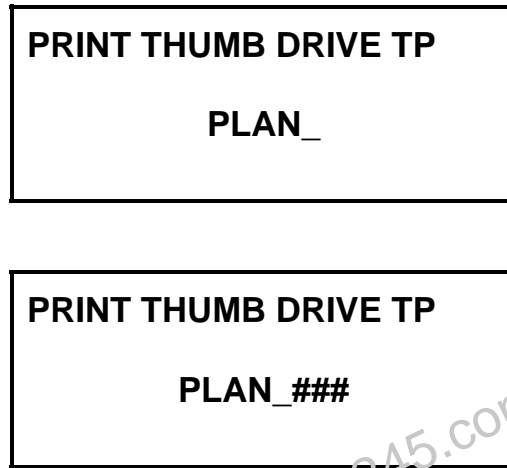

Figure 88.0 Print Thumb Drive Test Plan Status Displays

- a. **Description:** Allows the operator to enter a thumb drive test plan number to be printed.
- b. **Origin:** This menu is displayed after the operator selects menu option 1 (“Print Internal Tp”) from the “Print Test Plan With Thumb Drive Menu” (Figure 87.0).
- c. **Action Options:** Enter the test plan to print from the thumb drive using key numbers 0 through 9. Press the “CLEAR” key to enter another number. Press the “ENTER” key or push down the Control Knob to confirm.
- d. **Status Displays:** The top status displays first. The bottom status display indicates the test plan number entered by the operator.

### 25.13 Erase Test Plan With Thumb Drive Menu



**Figure 89.0 Erase Test Plan With Thumb Drive Menu**

- a. **Description:** Allows the operator to erase a test plan from the internal memory or from the thumb drive.
- b. **Origin:** This menu is displayed after the operator selects menu option 5 (“Erase Test Plan”) from the “Test Plan With Thumb Drive Menu” (Figure 81.0).
- c. **Action Options:** Press key number 1 or push down the Control Knob to erase an internal test plan. To erase a thumb drive test plan, press key number 2. Selection of number 2 may be made by turning the Control Knob to 2 and pushing down the Control Knob after number 2 is selected.

25.14 Erase Thumb Drive Test Plan Status Displays

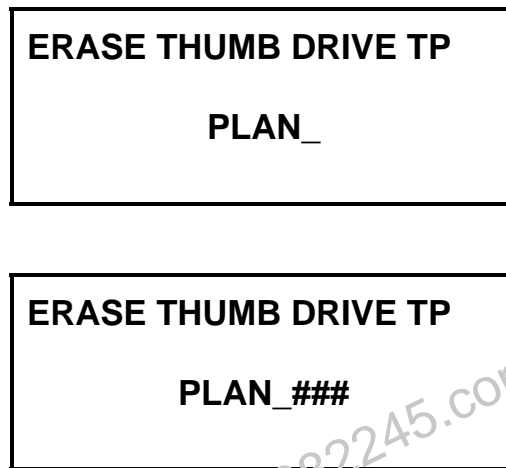

Figure 90.0 Erase Thumb Drive Test Plan Status Displays

- a. **Description:** Allows the operator to enter a thumb drive test plan number to be erased.
- b. **Origin:** This menu is displayed after the operator selects 1 (“Erase Internal Tp”) from the “Erase Test Plan With Thumb Drive Menu” (Figure 89.0).
- c. **Action Options:** Enter the test plan to erase from the thumb drive using key numbers 0 through 9. Press the “CLEAR” key to enter another number. Press the “ENTER” key or push down the Control Knob to confirm.
- d. **Status Displays:** The top status displays first. The bottom status display indicates the test plan number entered by the operator.

## 25.15 Save Test Plan With Thumb Drive Menu



**Figure 91.0 Save Test Plan With Thumb Drive Menu**

- a. **Description:** Allows the operator to save a test plan to internal memory or to the thumb drive.
- b. **Origin:** This menu is displayed after the operator selects menu option 6 (“Save Test Plan”) from the “Test Plan With Thumb Drive Menu” (Figure 81.0).
- c. **Action Options:** Press key number 1 or push down the Control Knob to save an internal test plan. To save a test plan from internal memory to the thumb drive, press key number 2. Selection of number 2 may be made by turning the Control Knob to 2 and pushing down the Control Knob after number 2 is selected.

**NOTE:**

*A test plan must be loaded in internal FLASH EEPROM memory.*

## 26.0 Computer Interface Description

### 26.1 Computer Interface Status Display

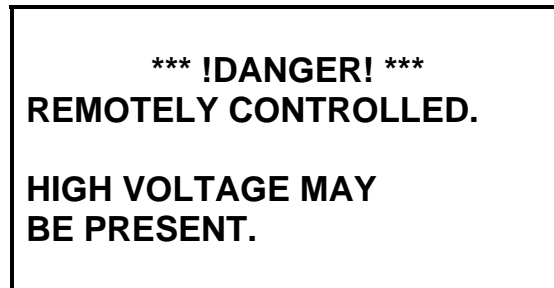

**Figure 92.0 Computer Interface Status Display**

- a. **Description:** Testing may be remotely controlled via an IBM-compatible PC through either an RS-232C port or through the USB port using the TTRA software application. Using this software application, the user has the ability to
- Transfer test records stored in the FLASH EEPROM to the PC
  - Transfer transformer test plans generated with the software application into the FLASH EEPROM memory
  - Run tests under control of the PC
- b. **Origin:** Connection of either the RS-232C or the USB cables between the TRI-PHASE™ and the PC. Initiating the TTRA software application on the PC.
- c. **Action Option:** Initiate the TTRA software application on the PC.

**NOTE:**

*From the TTRA software application, the user can select the USB or RS-232 port.*



## **26.2 Emergency Turn Off Switch**

The emergency turn off button switch (Figure 1.0 and Table 4.0 index 2) provides for those situations where immediate removal of power output from the TRI-PHASE™ to the transformer under test is necessary for safety of the test personal. To immediately turn off output power from the TRI-PHASE™ to the transformer under test push down on the button switch. When the emergency turn off button switch is pushed down it remains locked in this position and the following message is displayed on the LCD.



**Figure 93.0 Computer Interface Status Display**

To reset the emergency turn off button switch, twist button in the direction indicated by the arrows.

## 27.0 TRI-PHASE™ Firmware Programming Notes

The TRI-PHASE™ firmware may be updated anytime by the users in the field. The current firmware revision is posted under “Downloads” on the Vanguard Instruments web site ([www.vanguard-instruments.com](http://www.vanguard-instruments.com)).

To request a copy of the TRI-PHASE™ firmware, select the “Downloads” option on the web site. The user is then required to fill out the request form. The user needs to select the check mark on the corresponding TRI-PHASE™ firmware request on the form. The firmware request is then processed by Vanguard personnel after it is received from the user. The firmware download zip file is then sent to the user via the users email account. The zip file contains two files, the “TRIPHASE.hex” file and the “Firmware Programming Notes for TRIPHASE.doc” file. The HEX file is the firmware update and the *Microsoft Word* file contains the instructions which are shown below. It is important to place the HEX file in the root directory; otherwise the TRI-PHASE™ will not be able to locate the file.

Follow the following procedure to update the firmware for the TRI-PHASE™.

1. Copy the TRIPHASE.HEX file to the root directory of a USB thumb drive.
2. Power down (i.e., turn off) the TRI-PHASE™.
3. Insert the USB thumb drive into the TRI-PHASE™ USB thumb drive port on the front panel.
4. Press and hold down the “STOP” key while powering-up the TRI-PHASE™ until the “Start Handshake or Insert Thumb Drive” message appears on the LCD. Release the “STOP” key, and insert the Thumb Drive.
5. The TRI-PHASE will display erase messages as it removes old firmware components.
6. The TRI-PHASE™ will now automatically update its firmware and display a message on the LCD that it is performing the firmware update.
7. The TRI\_PHASE will now reboot itself.
8. Verify the new firmware revision on the TRI-PHASE™ as it is displayed on the LCD.

The following figures depict the LCD displays during power-up of the TRI-PHASE™. The firmware version is displayed on the TRI-PHASE™ LCD during power-up.

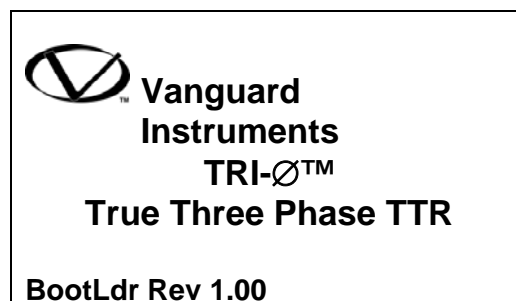

**Figure 94.0 Firmware Revision Menu 1**

27.0 TRI-PHASE™ Firmware Programming Notes (continued)



Figure 95.0 Firmware Revision Menu 2



Figure 96.0 Firmware Revision Menu 3

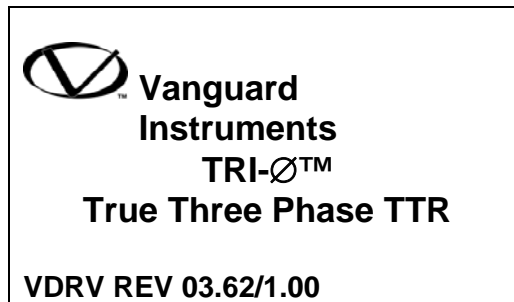

Figure 97.0 Firmware Revision Menu 3

27.0 TRI-PHASE™ Firmware Programming Notes (continued)



Figure 98.0 Firmware Revision Menu 4



Figure 99.0 Firmware Revision Menu 5

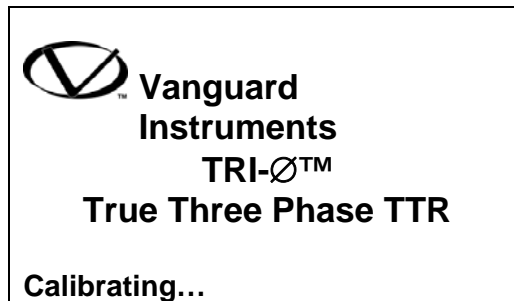

Figure 100.0 Firmware Revision Menu 6

APPENDIX A

TRANSFORMER VECTOR GROUP CODES

Utility power transformers manufactured in accordance with IEC specifications have a Rating Plate attached in a visible location which contains a list of the transformer's configuration and operating specifications. One such rating is the winding configuration and phase-displacement code. This code follows a convention that comprises letter and number sets that denote three-phase winding configurations (i.e., Wye, delta, or zig-zag). Letter symbols for the different windings are noted in descending order of their rated voltages. That is, symbols denoting higher voltage ratings will be upper-case (i.e., capital) letters and symbols denoting lower or intermediate voltage ratings will be lower-case letters. If the neutral point of either a wye or zig-zag winding is brought out, the indication shall be an N (high voltage) or n (lower voltage). The end numeral is a 30° multiplier that indicates phase lag between windings.

Accordingly, the following standard practice applies:

Wye (or star) = Y (high voltage) or y (low voltage)

Delta = D (high voltage) or d (low voltage)

Zig-zag = Z (high voltage) or z (low voltage)

An example: **Dyn11** which decodes as follows:

**D** indicates that the high-voltage windings are connected in a Delta configuration

(Since delta windings do not have a neutral point, the N never appears after a D).

**y** indicates that the lower voltage winding is in a wye (or star) configuration.

**n** indicates that the lower voltage windings have the neutral point brought out.

**11** indicates a phase-displacement lag of 330 degrees between the Wye and the Delta winding.

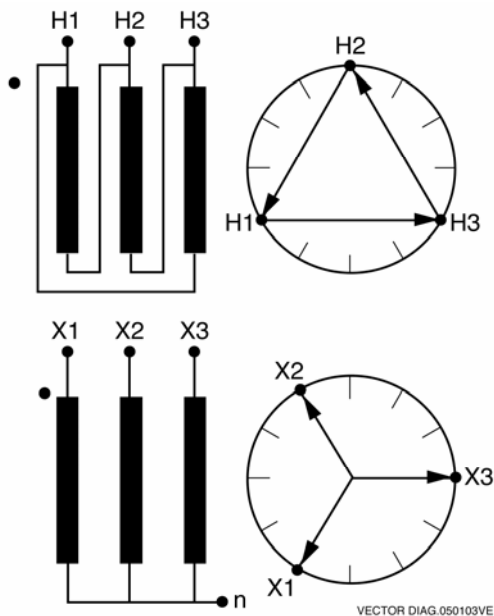

APPENDIX B

ANSI Transformers Description

| TRANSFORMER CONFIGURATION |                         | VECTOR GROUP | P H A S E | WINDING TESTED                  |                                 |                                 | MEAS RATIO                       | TURNS RATIO                      | NOTES                                |
|---------------------------|-------------------------|--------------|-----------|---------------------------------|---------------------------------|---------------------------------|----------------------------------|----------------------------------|--------------------------------------|
| HIGH-VOLTAGE WINDING (H)  | LOW-VOLTAGE WINDING (X) |              |           | INTERNAL JUMPER                 | HIGH VOLTAGE WINDING            | LOW VOLTAGE WINDING             |                                  |                                  |                                      |
|                           |                         | single phase |           |                                 | H <sub>1</sub> - H <sub>2</sub> | X <sub>1</sub> - X <sub>2</sub> | $\frac{V_H}{V_x}$                | $\frac{V_H}{V_x}$                |                                      |
|                           |                         | Dy1          | A         | H <sub>3</sub> - H <sub>2</sub> | H <sub>1</sub> - H <sub>3</sub> | X <sub>1</sub> - X <sub>3</sub> | $\frac{V_H}{V_x} \cdot \sqrt{3}$ | $\frac{V_H}{V_x} \cdot \sqrt{3}$ | NO ACCESSIBLE NEUTRAL ON LOW WINDING |
|                           |                         |              | B         | H <sub>1</sub> - H <sub>3</sub> | H <sub>2</sub> - H <sub>1</sub> | X <sub>2</sub> - X <sub>1</sub> |                                  |                                  |                                      |
|                           |                         |              | C         | H <sub>2</sub> - H <sub>1</sub> | H <sub>3</sub> - H <sub>2</sub> | X <sub>3</sub> - X <sub>2</sub> |                                  |                                  |                                      |
|                           |                         | Dy3          | A         | H <sub>3</sub> - H <sub>2</sub> | H <sub>1</sub> - H <sub>3</sub> | X <sub>1</sub> - X <sub>2</sub> | $\frac{V_H}{V_x} \cdot \sqrt{3}$ | $\frac{V_H}{V_x} \cdot \sqrt{3}$ | NO ACCESSIBLE NEUTRAL ON LOW WINDING |
|                           |                         |              | B         | H <sub>1</sub> - H <sub>3</sub> | H <sub>2</sub> - H <sub>1</sub> | X <sub>2</sub> - X <sub>3</sub> |                                  |                                  |                                      |
|                           |                         |              | C         | H <sub>2</sub> - H <sub>1</sub> | H <sub>3</sub> - H <sub>2</sub> | X <sub>3</sub> - X <sub>1</sub> |                                  |                                  |                                      |
|                           |                         | Dy5          | A         | H <sub>3</sub> - H <sub>2</sub> | H <sub>1</sub> - H <sub>3</sub> | X <sub>3</sub> - X <sub>2</sub> | $\frac{V_H}{V_x} \cdot \sqrt{3}$ | $\frac{V_H}{V_x} \cdot \sqrt{3}$ | NO ACCESSIBLE NEUTRAL ON LOW WINDING |
|                           |                         |              | B         | H <sub>1</sub> - H <sub>3</sub> | H <sub>2</sub> - H <sub>1</sub> | X <sub>1</sub> - X <sub>3</sub> |                                  |                                  |                                      |
|                           |                         |              | C         | H <sub>2</sub> - H <sub>1</sub> | H <sub>3</sub> - H <sub>2</sub> | X <sub>2</sub> - X <sub>1</sub> |                                  |                                  |                                      |
|                           |                         | Dy7          | A         | H <sub>3</sub> - H <sub>2</sub> | H <sub>1</sub> - H <sub>3</sub> | X <sub>3</sub> - X <sub>1</sub> | $\frac{V_H}{V_x} \cdot \sqrt{3}$ | $\frac{V_H}{V_x} \cdot \sqrt{3}$ | NO ACCESSIBLE NEUTRAL ON LOW WINDING |
|                           |                         |              | B         | H <sub>1</sub> - H <sub>3</sub> | H <sub>2</sub> - H <sub>1</sub> | X <sub>1</sub> - X <sub>2</sub> |                                  |                                  |                                      |
|                           |                         |              | C         | H <sub>2</sub> - H <sub>1</sub> | H <sub>3</sub> - H <sub>2</sub> | X <sub>2</sub> - X <sub>3</sub> |                                  |                                  |                                      |
|                           |                         | Dy9          | A         | H <sub>3</sub> - H <sub>2</sub> | H <sub>1</sub> - H <sub>3</sub> | X <sub>2</sub> - X <sub>1</sub> | $\frac{V_H}{V_x} \cdot \sqrt{3}$ | $\frac{V_H}{V_x} \cdot \sqrt{3}$ | NO ACCESSIBLE NEUTRAL ON LOW WINDING |
|                           |                         |              | B         | H <sub>1</sub> - H <sub>3</sub> | H <sub>2</sub> - H <sub>1</sub> | X <sub>3</sub> - X <sub>2</sub> |                                  |                                  |                                      |
|                           |                         |              | C         | H <sub>2</sub> - H <sub>1</sub> | H <sub>3</sub> - H <sub>2</sub> | X <sub>1</sub> - X <sub>3</sub> |                                  |                                  |                                      |
|                           |                         | Dy11         | A         | H <sub>3</sub> - H <sub>2</sub> | H <sub>1</sub> - H <sub>3</sub> | X <sub>2</sub> - X <sub>3</sub> | $\frac{V_H}{V_x} \cdot \sqrt{3}$ | $\frac{V_H}{V_x} \cdot \sqrt{3}$ | NO ACCESSIBLE NEUTRAL ON LOW WINDING |
|                           |                         |              | B         | H <sub>1</sub> - H <sub>3</sub> | H <sub>2</sub> - H <sub>1</sub> | X <sub>3</sub> - X <sub>1</sub> |                                  |                                  |                                      |
|                           |                         |              | C         | H <sub>2</sub> - H <sub>1</sub> | H <sub>3</sub> - H <sub>2</sub> | X <sub>1</sub> - X <sub>2</sub> |                                  |                                  |                                      |
|                           |                         | Dyn1         | A         |                                 | H <sub>1</sub> - H <sub>3</sub> | X <sub>1</sub> - X <sub>0</sub> | $\frac{V_H}{V_x} \cdot \sqrt{3}$ | $\frac{V_H}{V_x} \cdot \sqrt{3}$ |                                      |
|                           |                         |              | B         |                                 | H <sub>2</sub> - H <sub>1</sub> | X <sub>2</sub> - X <sub>0</sub> |                                  |                                  |                                      |
|                           |                         |              | C         |                                 | H <sub>3</sub> - H <sub>2</sub> | X <sub>3</sub> - X <sub>0</sub> |                                  |                                  |                                      |
|                           |                         | Dyn3         | A         |                                 | H <sub>1</sub> - H <sub>3</sub> | X <sub>0</sub> - X <sub>2</sub> | $\frac{V_H}{V_x} \cdot \sqrt{3}$ | $\frac{V_H}{V_x} \cdot \sqrt{3}$ |                                      |
|                           |                         |              | B         |                                 | H <sub>2</sub> - H <sub>1</sub> | X <sub>0</sub> - X <sub>3</sub> |                                  |                                  |                                      |
|                           |                         |              | C         |                                 | H <sub>3</sub> - H <sub>2</sub> | X <sub>0</sub> - X <sub>1</sub> |                                  |                                  |                                      |
|                           |                         | Dyn5         | A         |                                 | H <sub>1</sub> - H <sub>3</sub> | X <sub>3</sub> - X <sub>0</sub> | $\frac{V_H}{V_x} \cdot \sqrt{3}$ | $\frac{V_H}{V_x} \cdot \sqrt{3}$ |                                      |
|                           |                         |              | B         |                                 | H <sub>2</sub> - H <sub>1</sub> | X <sub>1</sub> - X <sub>0</sub> |                                  |                                  |                                      |
|                           |                         |              | C         |                                 | H <sub>3</sub> - H <sub>2</sub> | X <sub>2</sub> - X <sub>0</sub> |                                  |                                  |                                      |

NOTES:

651 VANGUARD080308V1

- 1) Meas Ratio is the ratio measured by the instrument, where V<sub>H</sub>, V<sub>X</sub>, are the Nameplate Voltages.
- 2) Turns Ratio is the physical ratio of the number of turns on the core, expressed in terms of V<sub>H</sub> and V<sub>X</sub>.

APPENDIX B (continued)

ANSI Transformers Description

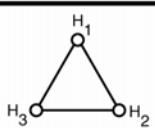
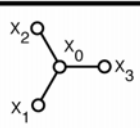
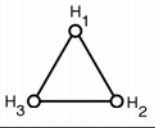
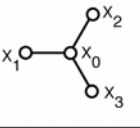
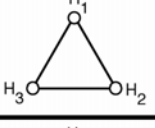
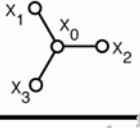
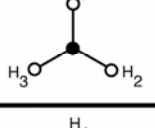
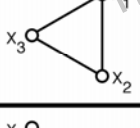
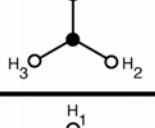
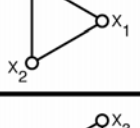
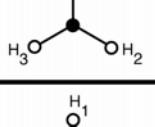
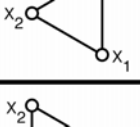
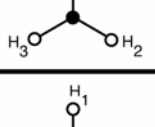
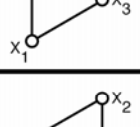
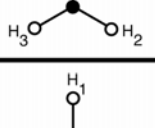
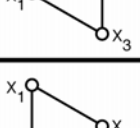
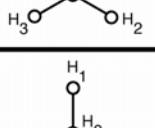
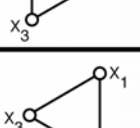
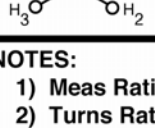
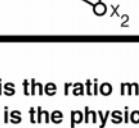
| TRANSFORMER CONFIGURATION   |   | VECTOR GROUP | PHASE | WINDING TESTED  |                      |                     | MEAS RATIO                                 | TURNS RATIO                      | NOTES                                 |
|---|---|--------------|-------|-----------------|----------------------|---------------------|--|----------------------------------|---------------------------------------|
| HIGH-VOLTAGE WINDING (H)  | LOW-VOLTAGE WINDING (X)   |              |       | INTERNAL JUMPER | HIGH VOLTAGE WINDING | LOW VOLTAGE WINDING |  |                                  |                                       |
|    |    | Dyn7         | A     |                 | H1-H3                | X0-X1               | $\frac{V_H}{V_X} \cdot \sqrt{3}$           | $\frac{V_H}{V_X} \cdot \sqrt{3}$ |                                       |
|   |   |              | B     |                 | H2-H1                | X0-X2               |  |                                  |                                       |
|   |   |              | C     |                 | H3-H2                | X0-X3               |  |                                  |                                       |
|    |    | Dyn9         | A     |                 | H1-H3                | X2-X0               | $\frac{V_H}{V_X} \cdot \sqrt{3}$           | $\frac{V_H}{V_X} \cdot \sqrt{3}$ |                                       |
|   |   |              | B     |                 | H2-H1                | X3-X0               |  |                                  |                                       |
|   |   |              | C     |                 | H3-H2                | X1-X0               |  |                                  |                                       |
|    |    | Dyn11        | A     |                 | H1-H3                | X0-X3               | $\frac{V_H}{V_X} \cdot \sqrt{3}$           | $\frac{V_H}{V_X} \cdot \sqrt{3}$ |                                       |
|   |   |              | B     |                 | H2-H1                | X0-X1               |  |                                  |                                       |
|   |   |              | C     |                 | H3-H2                | X0-X2               |  |                                  |                                       |
|   |   | Yd1          | A     | H3-H2           | H1-H3                | X1-X2               | $\frac{V_H}{V_X} \cdot \frac{\sqrt{3}}{2}$ | $\frac{V_H}{V_X \cdot \sqrt{3}}$ | NO ACCESSIBLE NEUTRAL ON HIGH WINDING |
|   |   |              | B     | H1-H3           | H2-H1                | X2-X3               |  |                                  |                                       |
|   |   |              | C     | H2-H1           | H3-H2                | X3-X1               |  |                                  |                                       |
|  |  | Yd3          | A     | H3-H2           | H1-H3                | X3-X2               | $\frac{V_H}{V_X} \cdot \frac{\sqrt{3}}{2}$ | $\frac{V_H}{V_X \cdot \sqrt{3}}$ | NO ACCESSIBLE NEUTRAL ON HIGH WINDING |
|   |   |              | B     | H1-H3           | H2-H1                | X1-X3               |  |                                  |                                       |
|   |   |              | C     | H2-H1           | H3-H2                | X2-X1               |  |                                  |                                       |
|  |  | Yd5          | A     | H3-H2           | H1-H3                | X3-X1               | $\frac{V_H}{V_X} \cdot \frac{\sqrt{3}}{2}$ | $\frac{V_H}{V_X \cdot \sqrt{3}}$ | NO ACCESSIBLE NEUTRAL ON HIGH WINDING |
|   |   |              | B     | H1-H3           | H2-H1                | X1-X2               |  |                                  |                                       |
|   |   |              | C     | H2-H1           | H3-H2                | X2-X3               |  |                                  |                                       |
|  |  | Yd7          | A     | H3-H2           | H1-H3                | X2-X1               | $\frac{V_H}{V_X} \cdot \frac{\sqrt{3}}{2}$ | $\frac{V_H}{V_X \cdot \sqrt{3}}$ | NO ACCESSIBLE NEUTRAL ON HIGH WINDING |
|   |   |              | B     | H1-H3           | H2-H1                | X3-X2               |  |                                  |                                       |
|   |   |              | C     | H2-H1           | H3-H2                | X1-X3               |  |                                  |                                       |
|  |  | Yd9          | A     | H3-H2           | H1-H3                | X2-X3               | $\frac{V_H}{V_X} \cdot \frac{\sqrt{3}}{2}$ | $\frac{V_H}{V_X \cdot \sqrt{3}}$ | NO ACCESSIBLE NEUTRAL ON HIGH WINDING |
|   |   |              | B     | H1-H3           | H2-H1                | X3-X1               |  |                                  |                                       |
|   |   |              | C     | H2-H1           | H3-H2                | X1-X2               |  |                                  |                                       |
|  |  | Yd11         | A     | H3-H2           | H1-H3                | X1-X3               | $\frac{V_H}{V_X} \cdot \frac{\sqrt{3}}{2}$ | $\frac{V_H}{V_X \cdot \sqrt{3}}$ | NO ACCESSIBLE NEUTRAL ON HIGH WINDING |
|   |   |              | B     | H1-H3           | H2-H1                | X2-X1               |  |                                  |                                       |
|   |   |              | C     | H2-H1           | H3-H2                | X3-X2               |  |                                  |                                       |
|  |  | YNd1         | A     |                 | H1-H0                | X1-X2               | $\frac{V_H}{V_X \cdot \sqrt{3}}$           | $\frac{V_H}{V_X \cdot \sqrt{3}}$ |                                       |
|   |   |              | B     |                 | H2-H0                | X2-X3               |  |                                  |                                       |
|   |   |              | C     |                 | H3-H0                | X3-X1               |  |                                  |                                       |

NOTES:

651VANGUARD080308V2

- 1) Meas Ratio is the ratio measured by the instrument, where V<sub>H</sub>, V<sub>X</sub>, are the Nameplate Voltages.
- 2) Turns Ratio is the physical ratio of the number of turns on the core, expressed in terms of V<sub>H</sub> and V<sub>X</sub>.

APPENDIX B (continued)

ANSI Transformers Description

| TRANSFORMER CONFIGURATION |                         | VECTOR GROUP | PHASE | WINDING TESTED  |                                 |                                 | MEAS RATIO                       | TURNS RATIO       | NOTES |
|---------------------------|-------------------------|--------------|-------|-----------------|---------------------------------|---------------------------------|----------------------------------|-------------------|-------|
| HIGH-VOLTAGE WINDING (H)  | LOW-VOLTAGE WINDING (X) |              |       | INTERNAL JUMPER | HIGH VOLTAGE WINDING            | LOW VOLTAGE WINDING             |                                  |                   |       |
|                           |                         | YNd3         | A     |                 | H <sub>1</sub> - H <sub>0</sub> | X <sub>3</sub> - X <sub>2</sub> | $\frac{V_H}{V_X \cdot \sqrt{3}}$ | $\frac{V_H}{V_X}$ |       |
|                           |                         |              | B     |                 | H <sub>2</sub> - H <sub>0</sub> | X <sub>1</sub> - X <sub>3</sub> |                                  |                   |       |
|                           |                         |              | C     |                 | H <sub>3</sub> - H <sub>0</sub> | X <sub>2</sub> - X <sub>1</sub> |                                  |                   |       |
|                           |                         | YNd5         | A     |                 | H <sub>1</sub> - H <sub>0</sub> | X <sub>3</sub> - X <sub>1</sub> | $\frac{V_H}{V_X \cdot \sqrt{3}}$ | $\frac{V_H}{V_X}$ |       |
|                           |                         |              | B     |                 | H <sub>2</sub> - H <sub>0</sub> | X <sub>1</sub> - X <sub>2</sub> |                                  |                   |       |
|                           |                         |              | C     |                 | H <sub>3</sub> - H <sub>0</sub> | X <sub>2</sub> - X <sub>3</sub> |                                  |                   |       |
|                           |                         | YNd7         | A     |                 | H <sub>1</sub> - H <sub>0</sub> | X <sub>2</sub> - X <sub>1</sub> | $\frac{V_H}{V_X \cdot \sqrt{3}}$ | $\frac{V_H}{V_X}$ |       |
|                           |                         |              | B     |                 | H <sub>2</sub> - H <sub>0</sub> | X <sub>3</sub> - X <sub>2</sub> |                                  |                   |       |
|                           |                         |              | C     |                 | H <sub>3</sub> - H <sub>0</sub> | X <sub>1</sub> - X <sub>3</sub> |                                  |                   |       |
|                           |                         | YNd9         | A     |                 | H <sub>1</sub> - H <sub>0</sub> | X <sub>2</sub> - X <sub>3</sub> | $\frac{V_H}{V_X \cdot \sqrt{3}}$ | $\frac{V_H}{V_X}$ |       |
|                           |                         |              | B     |                 | H <sub>2</sub> - H <sub>0</sub> | X <sub>3</sub> - X <sub>1</sub> |                                  |                   |       |
|                           |                         |              | C     |                 | H <sub>3</sub> - H <sub>0</sub> | X <sub>1</sub> - X <sub>2</sub> |                                  |                   |       |
|                           |                         | YNd11        | A     |                 | H <sub>1</sub> - H <sub>0</sub> | X <sub>1</sub> - X <sub>3</sub> | $\frac{V_H}{V_X \cdot \sqrt{3}}$ | $\frac{V_H}{V_X}$ |       |
|                           |                         |              | B     |                 | H <sub>2</sub> - H <sub>0</sub> | X <sub>2</sub> - X <sub>1</sub> |                                  |                   |       |
|                           |                         |              | C     |                 | H <sub>3</sub> - H <sub>0</sub> | X <sub>3</sub> - X <sub>2</sub> |                                  |                   |       |
|                           |                         | Dd0          | A     |                 | H <sub>1</sub> - H <sub>3</sub> | X <sub>1</sub> - X <sub>3</sub> | $\frac{V_H}{V_X}$                | $\frac{V_H}{V_X}$ |       |
|                           |                         |              | B     |                 | H <sub>2</sub> - H <sub>1</sub> | X <sub>2</sub> - X <sub>1</sub> |                                  |                   |       |
|                           |                         |              | C     |                 | H <sub>3</sub> - H <sub>2</sub> | X <sub>3</sub> - X <sub>2</sub> |                                  |                   |       |
|                           |                         | Dd2          | A     |                 | H <sub>1</sub> - H <sub>3</sub> | X <sub>1</sub> - X <sub>2</sub> | $\frac{V_H}{V_X}$                | $\frac{V_H}{V_X}$ |       |
|                           |                         |              | B     |                 | H <sub>2</sub> - H <sub>1</sub> | X <sub>2</sub> - X <sub>3</sub> |                                  |                   |       |
|                           |                         |              | C     |                 | H <sub>3</sub> - H <sub>2</sub> | X <sub>3</sub> - X <sub>1</sub> |                                  |                   |       |
|                           |                         | Dd4          | A     |                 | H <sub>1</sub> - H <sub>3</sub> | X <sub>3</sub> - X <sub>2</sub> | $\frac{V_H}{V_X}$                | $\frac{V_H}{V_X}$ |       |
|                           |                         |              | B     |                 | H <sub>2</sub> - H <sub>1</sub> | X <sub>1</sub> - X <sub>3</sub> |                                  |                   |       |
|                           |                         |              | C     |                 | H <sub>3</sub> - H <sub>2</sub> | X <sub>2</sub> - X <sub>1</sub> |                                  |                   |       |
|                           |                         | Dd6          | A     |                 | H <sub>1</sub> - H <sub>3</sub> | X <sub>3</sub> - X <sub>1</sub> | $\frac{V_H}{V_X}$                | $\frac{V_H}{V_X}$ |       |
|                           |                         |              | B     |                 | H <sub>2</sub> - H <sub>1</sub> | X <sub>1</sub> - X <sub>2</sub> |                                  |                   |       |
|                           |                         |              | C     |                 | H <sub>3</sub> - H <sub>2</sub> | X <sub>2</sub> - X <sub>3</sub> |                                  |                   |       |
|                           |                         | Dd8          | A     |                 | H <sub>1</sub> - H <sub>3</sub> | X <sub>2</sub> - X <sub>1</sub> | $\frac{V_H}{V_X}$                | $\frac{V_H}{V_X}$ |       |
|                           |                         |              | B     |                 | H <sub>2</sub> - H <sub>1</sub> | X <sub>3</sub> - X <sub>2</sub> |                                  |                   |       |
|                           |                         |              | C     |                 | H <sub>3</sub> - H <sub>2</sub> | X <sub>1</sub> - X <sub>3</sub> |                                  |                   |       |

NOTES:



651VANGUARD080308V3

- 1) Meas Ratio is the ratio measured by the instrument, where V<sub>H</sub>, V<sub>X</sub>, are the Nameplate Voltages.
- 2) Turns Ratio is the physical ratio of the number of turns on the core, expressed in terms of V<sub>H</sub> and V<sub>X</sub>.

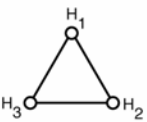
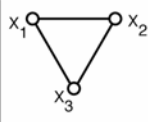
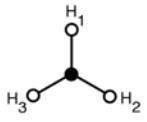
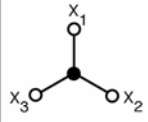
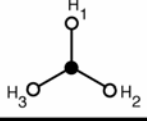
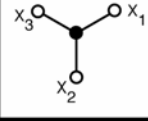
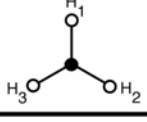

APPENDIX B (continued)

ANSI Transformers Description

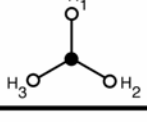
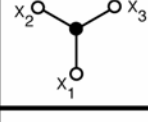
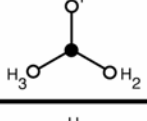
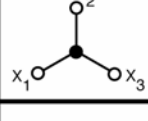
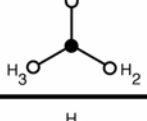
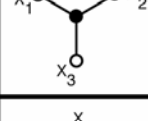
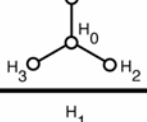
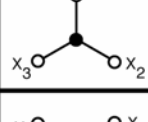
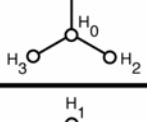
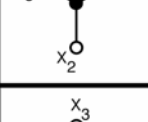
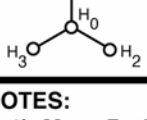
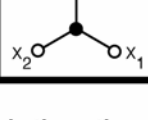
| TRANSFORMER CONFIGURATION   |   | VECTOR GROUP | PHASE | WINDING TESTED                  |                                 |                                 | MEAS RATIO        | TURNS RATIO       | NOTES                                |                                 |
|---|---|--------------|-------|---------------------------------|---------------------------------|---------------------------------|-------------------|-------------------|--------------------------------------|---------------------------------|
| HIGH-VOLTAGE WINDING (H)  | LOW-VOLTAGE WINDING (X)   |              |       | INTERNAL JUMPER                 | HIGH VOLTAGE WINDING            | LOW VOLTAGE WINDING             |                   |                   |                                      |                                 |
|    |    | Dd10         | A     |                                 | H <sub>1</sub> - H <sub>3</sub> | X <sub>2</sub> - X <sub>3</sub> | $\frac{V_H}{V_X}$ | $\frac{V_H}{V_X}$ |                                      |                                 |
|   |   |              | B     |                                 | H <sub>2</sub> - H <sub>1</sub> | X <sub>3</sub> - X <sub>1</sub> |                   |                   |                                      |                                 |
|   |   |              | C     |                                 | H <sub>3</sub> - H <sub>2</sub> | X <sub>1</sub> - X <sub>2</sub> |                   |                   |                                      |                                 |
|    |    | Yy0          | A     |                                 | H <sub>1</sub> - H <sub>3</sub> | X <sub>1</sub> - X <sub>3</sub> | $\frac{V_H}{V_X}$ | $\frac{V_H}{V_X}$ | NO ACCESSIBLE NEUTRAL                |                                 |
|   |   |              | B     |                                 | H <sub>2</sub> - H <sub>1</sub> | X <sub>2</sub> - X <sub>3</sub> |                   |                   |                                      |                                 |
|   |   |              | C     |                                 | H <sub>3</sub> - H <sub>2</sub> | X <sub>3</sub> - X <sub>2</sub> |                   |                   |                                      |                                 |
|    |    | Yy2          | A     |                                 | H <sub>1</sub> - H <sub>3</sub> | X <sub>1</sub> - X <sub>2</sub> | $\frac{V_H}{V_X}$ | $\frac{V_H}{V_X}$ | NO ACCESSIBLE NEUTRAL                |                                 |
|   |   |              | B     |                                 | H <sub>2</sub> - H <sub>1</sub> | X <sub>2</sub> - X <sub>3</sub> |                   |                   |                                      |                                 |
|   |   |              | C     |                                 | H <sub>3</sub> - H <sub>2</sub> | X <sub>3</sub> - X <sub>1</sub> |                   |                   |                                      |                                 |
|   |   | Yy4          | A     |                                 | H <sub>1</sub> - H <sub>3</sub> | X <sub>3</sub> - X <sub>2</sub> | $\frac{V_H}{V_X}$ | $\frac{V_H}{V_X}$ | NO ACCESSIBLE NEUTRAL                |                                 |
|   |   |              | B     |                                 | H <sub>2</sub> - H <sub>1</sub> | X <sub>1</sub> - X <sub>3</sub> |                   |                   |                                      |                                 |
|   |   |              | C     |                                 | H <sub>3</sub> - H <sub>2</sub> | X <sub>2</sub> - X <sub>1</sub> |                   |                   |                                      |                                 |
|  |  | Yy6          | A     |                                 | H <sub>1</sub> - H <sub>3</sub> | X <sub>3</sub> - X <sub>1</sub> | $\frac{V_H}{V_X}$ | $\frac{V_H}{V_X}$ | NO ACCESSIBLE NEUTRAL                |                                 |
|   |   |              | B     |                                 | H <sub>2</sub> - H <sub>1</sub> | X <sub>1</sub> - X <sub>2</sub> |                   |                   |                                      |                                 |
|   |   |              | C     |                                 | H <sub>3</sub> - H <sub>2</sub> | X <sub>2</sub> - X <sub>3</sub> |                   |                   |                                      |                                 |
|  |  | Yy8          | A     |                                 | H <sub>1</sub> - H <sub>3</sub> | X <sub>2</sub> - X <sub>1</sub> | $\frac{V_H}{V_X}$ | $\frac{V_H}{V_X}$ | NO ACCESSIBLE NEUTRAL                |                                 |
|   |   |              | B     |                                 | H <sub>2</sub> - H <sub>1</sub> | X <sub>3</sub> - X <sub>2</sub> |                   |                   |                                      |                                 |
|   |   |              | C     |                                 | H <sub>3</sub> - H <sub>2</sub> | X <sub>1</sub> - X <sub>3</sub> |                   |                   |                                      |                                 |
|  |  | Yy10         | A     |                                 | H <sub>1</sub> - H <sub>3</sub> | X <sub>2</sub> - X <sub>3</sub> | $\frac{V_H}{V_X}$ | $\frac{V_H}{V_X}$ | NO ACCESSIBLE NEUTRAL                |                                 |
|   |   |              | B     |                                 | H <sub>2</sub> - H <sub>1</sub> | X <sub>3</sub> - X <sub>1</sub> |                   |                   |                                      |                                 |
|   |   |              | C     |                                 | H <sub>3</sub> - H <sub>2</sub> | X <sub>1</sub> - X <sub>2</sub> |                   |                   |                                      |                                 |
|  |  | YNy0         | A     | H <sub>0</sub> - H <sub>2</sub> | H <sub>1</sub> - H <sub>0</sub> | X <sub>1</sub> - X <sub>2</sub> | $\frac{V_H}{V_X}$ | $\frac{V_H}{V_X}$ | NO ACCESSIBLE NEUTRAL ON LOW WINDING |                                 |
|   |   |              | B     |                                 | H <sub>0</sub> - H <sub>3</sub> | H <sub>2</sub> - H <sub>0</sub> |                   |                   |                                      | X <sub>2</sub> - X <sub>3</sub> |
|   |   |              | C     |                                 | H <sub>0</sub> - H <sub>1</sub> | H <sub>3</sub> - H <sub>0</sub> |                   |                   |                                      | X <sub>3</sub> - X <sub>1</sub> |
|  |  | YNy2         | A     | H <sub>0</sub> - H <sub>2</sub> | H <sub>1</sub> - H <sub>0</sub> | X <sub>3</sub> - X <sub>2</sub> | $\frac{V_H}{V_X}$ | $\frac{V_H}{V_X}$ | NO ACCESSIBLE NEUTRAL ON LOW WINDING |                                 |
|   |   |              | B     |                                 | H <sub>0</sub> - H <sub>3</sub> | H <sub>2</sub> - H <sub>0</sub> |                   |                   |                                      | X <sub>1</sub> - X <sub>3</sub> |
|   |   |              | C     |                                 | H <sub>0</sub> - H <sub>1</sub> | H <sub>3</sub> - H <sub>0</sub> |                   |                   |                                      | X <sub>2</sub> - X <sub>1</sub> |
|  |  | YNy4         | A     | H <sub>0</sub> - H <sub>2</sub> | H <sub>1</sub> - H <sub>0</sub> | X <sub>3</sub> - X <sub>1</sub> | $\frac{V_H}{V_X}$ | $\frac{V_H}{V_X}$ | NO ACCESSIBLE NEUTRAL ON LOW WINDING |                                 |
|   |   |              | B     |                                 | H <sub>0</sub> - H <sub>3</sub> | H <sub>2</sub> - H <sub>0</sub> |                   |                   |                                      | X <sub>1</sub> - X <sub>2</sub> |
|   |   |              | C     |                                 | H <sub>0</sub> - H <sub>1</sub> | H <sub>3</sub> - H <sub>0</sub> |                   |                   |                                      | X <sub>2</sub> - X <sub>3</sub> |

NOTES:

651VANGUARD080308V4

- 1) Meas Ratio is the ratio measured by the instrument, where V<sub>h</sub>, V<sub>x</sub>, are the Nameplate Voltages.
- 2) Turns Ratio is the physical ratio of the number of turns on the core, expressed in terms of V<sub>h</sub> and V<sub>x</sub>.

APPENDIX B (continued)

ANSI Transformers Description

| TRANSFORMER CONFIGURATION |                         | VECTOR GROUP | PHASE | WINDING TESTED                  |                                 |                                 | MEAS RATIO        | TURNS RATIO       | NOTES                                 |
|---------------------------|-------------------------|--------------|-------|---------------------------------|---------------------------------|---------------------------------|-------------------|-------------------|---------------------------------------|
| HIGH-VOLTAGE WINDING (H)  | LOW-VOLTAGE WINDING (X) |              |       | INTERNAL JUMPER                 | HIGH VOLTAGE WINDING            | LOW VOLTAGE WINDING             |                   |                   |                                       |
|                           |                         | YNy6         | A     | H <sub>0</sub> - H <sub>2</sub> | H <sub>1</sub> - H <sub>0</sub> | X <sub>2</sub> - X <sub>1</sub> | $\frac{V_H}{V_X}$ | $\frac{V_H}{V_X}$ | NO ACCESSIBLE NEUTRAL ON LOW WINDING  |
|                           |                         |              | B     | H <sub>0</sub> - H <sub>3</sub> | H <sub>2</sub> - H <sub>0</sub> | X <sub>3</sub> - X <sub>2</sub> |                   |                   |                                       |
|                           |                         |              | C     | H <sub>0</sub> - H <sub>1</sub> | H <sub>3</sub> - H <sub>0</sub> | X <sub>1</sub> - X <sub>3</sub> |                   |                   |                                       |
|                           |                         | YNy8         | A     | H <sub>0</sub> - H <sub>2</sub> | H <sub>1</sub> - H <sub>0</sub> | X <sub>2</sub> - X <sub>3</sub> | $\frac{V_H}{V_X}$ | $\frac{V_H}{V_X}$ | NO ACCESSIBLE NEUTRAL ON LOW WINDING  |
|                           |                         |              | B     | H <sub>0</sub> - H <sub>3</sub> | H <sub>2</sub> - H <sub>0</sub> | X <sub>3</sub> - X <sub>1</sub> |                   |                   |                                       |
|                           |                         |              | C     | H <sub>0</sub> - H <sub>1</sub> | H <sub>3</sub> - H <sub>0</sub> | X <sub>1</sub> - X <sub>2</sub> |                   |                   |                                       |
|                           |                         | YNy10        | A     | H <sub>0</sub> - H <sub>2</sub> | H <sub>1</sub> - H <sub>0</sub> | X <sub>1</sub> - X <sub>3</sub> | $\frac{V_H}{V_X}$ | $\frac{V_H}{V_X}$ | NO ACCESSIBLE NEUTRAL ON LOW WINDING  |
|                           |                         |              | B     | H <sub>0</sub> - H <sub>3</sub> | H <sub>2</sub> - H <sub>0</sub> | X <sub>2</sub> - X <sub>1</sub> |                   |                   |                                       |
|                           |                         |              | C     | H <sub>0</sub> - H <sub>1</sub> | H <sub>3</sub> - H <sub>0</sub> | X <sub>3</sub> - X <sub>2</sub> |                   |                   |                                       |
|                           |                         | Yyn0         | A     | X <sub>0</sub> - X <sub>3</sub> | H <sub>1</sub> - H <sub>3</sub> | X <sub>1</sub> - X <sub>0</sub> | $\frac{V_H}{V_X}$ | $\frac{V_H}{V_X}$ | NO ACCESSIBLE NEUTRAL ON HIGH WINDING |
|                           |                         |              | B     | X <sub>0</sub> - X <sub>1</sub> | H <sub>2</sub> - H <sub>1</sub> | X <sub>2</sub> - X <sub>0</sub> |                   |                   |                                       |
|                           |                         |              | C     | X <sub>0</sub> - X <sub>2</sub> | H <sub>3</sub> - H <sub>2</sub> | X <sub>3</sub> - X <sub>0</sub> |                   |                   |                                       |
|                           |                         | Yyn2         | A     | X <sub>0</sub> - X <sub>1</sub> | H <sub>1</sub> - H <sub>3</sub> | X <sub>0</sub> - X <sub>2</sub> | $\frac{V_H}{V_X}$ | $\frac{V_H}{V_X}$ | NO ACCESSIBLE NEUTRAL ON HIGH WINDING |
|                           |                         |              | B     | X <sub>0</sub> - X <sub>2</sub> | H <sub>2</sub> - H <sub>1</sub> | X <sub>0</sub> - X <sub>3</sub> |                   |                   |                                       |
|                           |                         |              | C     | X <sub>0</sub> - X <sub>3</sub> | H <sub>3</sub> - H <sub>2</sub> | X <sub>0</sub> - X <sub>1</sub> |                   |                   |                                       |
|                           |                         | Yyn4         | A     | X <sub>0</sub> - X <sub>2</sub> | H <sub>1</sub> - H <sub>3</sub> | X <sub>3</sub> - X <sub>0</sub> | $\frac{V_H}{V_X}$ | $\frac{V_H}{V_X}$ | NO ACCESSIBLE NEUTRAL ON HIGH WINDING |
|                           |                         |              | B     | X <sub>0</sub> - X <sub>3</sub> | H <sub>2</sub> - H <sub>1</sub> | X <sub>1</sub> - X <sub>0</sub> |                   |                   |                                       |
|                           |                         |              | C     | X <sub>0</sub> - X <sub>1</sub> | H <sub>3</sub> - H <sub>2</sub> | X <sub>2</sub> - X <sub>0</sub> |                   |                   |                                       |
|                           |                         | Yyn6         | A     | X <sub>0</sub> - X <sub>3</sub> | H <sub>1</sub> - H <sub>3</sub> | X <sub>0</sub> - X <sub>1</sub> | $\frac{V_H}{V_X}$ | $\frac{V_H}{V_X}$ | NO ACCESSIBLE NEUTRAL ON HIGH WINDING |
|                           |                         |              | B     | X <sub>0</sub> - X <sub>1</sub> | H <sub>2</sub> - H <sub>1</sub> | X <sub>0</sub> - X <sub>2</sub> |                   |                   |                                       |
|                           |                         |              | C     | X <sub>0</sub> - X <sub>2</sub> | H <sub>3</sub> - H <sub>2</sub> | X <sub>0</sub> - X <sub>3</sub> |                   |                   |                                       |
|                           |                         | Yyn8         | A     | X <sub>0</sub> - X <sub>1</sub> | H <sub>1</sub> - H <sub>3</sub> | X <sub>2</sub> - X <sub>0</sub> | $\frac{V_H}{V_X}$ | $\frac{V_H}{V_X}$ | NO ACCESSIBLE NEUTRAL ON HIGH WINDING |
|                           |                         |              | B     | X <sub>0</sub> - X <sub>2</sub> | H <sub>2</sub> - H <sub>1</sub> | X <sub>3</sub> - X <sub>0</sub> |                   |                   |                                       |
|                           |                         |              | C     | X <sub>0</sub> - X <sub>3</sub> | H <sub>3</sub> - H <sub>2</sub> | X <sub>1</sub> - X <sub>0</sub> |                   |                   |                                       |
|                           |                         | Yyn10        | A     | X <sub>0</sub> - X <sub>2</sub> | H <sub>1</sub> - H <sub>3</sub> | X <sub>0</sub> - X <sub>3</sub> | $\frac{V_H}{V_X}$ | $\frac{V_H}{V_X}$ | NO ACCESSIBLE NEUTRAL ON HIGH WINDING |
|                           |                         |              | B     | X <sub>0</sub> - X <sub>3</sub> | H <sub>2</sub> - H <sub>1</sub> | X <sub>0</sub> - X <sub>1</sub> |                   |                   |                                       |
|                           |                         |              | C     | X <sub>0</sub> - X <sub>1</sub> | H <sub>3</sub> - H <sub>2</sub> | X <sub>0</sub> - X <sub>2</sub> |                   |                   |                                       |
|                           |                         | YNyn0        | A     |                                 | H <sub>1</sub> - H <sub>0</sub> | X <sub>1</sub> - X <sub>0</sub> | $\frac{V_H}{V_X}$ | $\frac{V_H}{V_X}$ |                                       |
|                           |                         |              | B     |                                 | H <sub>2</sub> - H <sub>0</sub> | X <sub>2</sub> - X <sub>0</sub> |                   |                   |                                       |
|                           |                         |              | C     |                                 | H <sub>3</sub> - H <sub>0</sub> | X <sub>3</sub> - X <sub>0</sub> |                   |                   |                                       |

NOTES:

651 VANGUARD080308V5

- 1) Meas Ratio is the ratio measured by the instrument, where V<sub>H</sub>, V<sub>X</sub>, are the Nameplate Voltages.
- 2) Turns Ratio is the physical ratio of the number of turns on the core, expressed in terms of V<sub>H</sub> and V<sub>X</sub>.

APPENDIX B (continued)

ANSI Transformers Description

| TRANSFORMER CONFIGURATION |                         | VECTOR GROUP | PHASE | WINDING TESTED  |                                 |                                 | MEAS RATIO        | TURNS RATIO               | NOTES                                |
|---------------------------|-------------------------|--------------|-------|-----------------|---------------------------------|---------------------------------|-------------------|---------------------------|--------------------------------------|
| HIGH-VOLTAGE WINDING (H)  | LOW-VOLTAGE WINDING (X) |              |       | INTERNAL JUMPER | HIGH VOLTAGE WINDING            | LOW VOLTAGE WINDING             |                   |                           |                                      |
|                           |                         | Yyn2         | A     |                 | H <sub>1</sub> - H <sub>0</sub> | X <sub>0</sub> - X <sub>2</sub> | $\frac{V_H}{V_X}$ | $\frac{V_H}{V_X}$         |                                      |
|                           |                         |              | B     |                 | H <sub>2</sub> - H <sub>0</sub> | X <sub>0</sub> - X <sub>3</sub> |                   |                           |                                      |
|                           |                         |              | C     |                 | H <sub>3</sub> - H <sub>0</sub> | X <sub>0</sub> - X <sub>1</sub> |                   |                           |                                      |
|                           |                         | Yyn4         | A     |                 | H <sub>1</sub> - H <sub>0</sub> | X <sub>3</sub> - X <sub>0</sub> | $\frac{V_H}{V_X}$ | $\frac{V_H}{V_X}$         |                                      |
|                           |                         |              | B     |                 | H <sub>2</sub> - H <sub>0</sub> | X <sub>1</sub> - X <sub>0</sub> |                   |                           |                                      |
|                           |                         |              | C     |                 | H <sub>3</sub> - H <sub>0</sub> | X <sub>2</sub> - X <sub>0</sub> |                   |                           |                                      |
|                           |                         | Yyn6         | A     |                 | H <sub>1</sub> - H <sub>0</sub> | X <sub>0</sub> - X <sub>1</sub> | $\frac{V_H}{V_X}$ | $\frac{V_H}{V_X}$         |                                      |
|                           |                         |              | B     |                 | H <sub>2</sub> - H <sub>0</sub> | X <sub>0</sub> - X <sub>2</sub> |                   |                           |                                      |
|                           |                         |              | C     |                 | H <sub>3</sub> - H <sub>0</sub> | X <sub>0</sub> - X <sub>3</sub> |                   |                           |                                      |
|                           |                         | Yyn8         | A     |                 | H <sub>1</sub> - H <sub>0</sub> | X <sub>2</sub> - X <sub>0</sub> | $\frac{V_H}{V_X}$ | $\frac{V_H}{V_X}$         |                                      |
|                           |                         |              | B     |                 | H <sub>2</sub> - H <sub>0</sub> | X <sub>3</sub> - X <sub>0</sub> |                   |                           |                                      |
|                           |                         |              | C     |                 | H <sub>3</sub> - H <sub>0</sub> | X <sub>1</sub> - X <sub>0</sub> |                   |                           |                                      |
|                           |                         | Yyn10        | A     |                 | H <sub>1</sub> - H <sub>0</sub> | X <sub>0</sub> - X <sub>3</sub> | $\frac{V_H}{V_X}$ | $\frac{V_H}{V_X}$         |                                      |
|                           |                         |              | B     |                 | H <sub>2</sub> - H <sub>0</sub> | X <sub>0</sub> - X <sub>1</sub> |                   |                           |                                      |
|                           |                         |              | C     |                 | H <sub>3</sub> - H <sub>0</sub> | X <sub>0</sub> - X <sub>2</sub> |                   |                           |                                      |
|                           |                         | Dz0          | A     |                 | H <sub>1</sub> - H <sub>3</sub> | X <sub>1</sub> - X <sub>3</sub> | $\frac{V_H}{V_X}$ | $3 \cdot \frac{V_H}{V_X}$ | NO ACCESSIBLE NEUTRAL ON LOW WINDING |
|                           |                         |              | B     |                 | H <sub>2</sub> - H <sub>1</sub> | X <sub>2</sub> - X <sub>1</sub> |                   |                           |                                      |
|                           |                         |              | C     |                 | H <sub>3</sub> - H <sub>2</sub> | X <sub>3</sub> - X <sub>2</sub> |                   |                           |                                      |
|                           |                         | Dz2          | A     |                 | H <sub>1</sub> - H <sub>3</sub> | X <sub>1</sub> - X <sub>2</sub> | $\frac{V_H}{V_X}$ | $3 \cdot \frac{V_H}{V_X}$ | NO ACCESSIBLE NEUTRAL ON LOW WINDING |
|                           |                         |              | B     |                 | H <sub>2</sub> - H <sub>1</sub> | X <sub>2</sub> - X <sub>3</sub> |                   |                           |                                      |
|                           |                         |              | C     |                 | H <sub>3</sub> - H <sub>2</sub> | X <sub>3</sub> - X <sub>1</sub> |                   |                           |                                      |
|                           |                         | Dz4          | A     |                 | H <sub>1</sub> - H <sub>3</sub> | X <sub>3</sub> - X <sub>2</sub> | $\frac{V_H}{V_X}$ | $3 \cdot \frac{V_H}{V_X}$ | NO ACCESSIBLE NEUTRAL ON LOW WINDING |
|                           |                         |              | B     |                 | H <sub>2</sub> - H <sub>1</sub> | X <sub>1</sub> - X <sub>3</sub> |                   |                           |                                      |
|                           |                         |              | C     |                 | H <sub>3</sub> - H <sub>2</sub> | X <sub>2</sub> - X <sub>1</sub> |                   |                           |                                      |
|                           |                         | Dz6          | A     |                 | H <sub>1</sub> - H <sub>3</sub> | X <sub>3</sub> - X <sub>1</sub> | $\frac{V_H}{V_X}$ | $3 \cdot \frac{V_H}{V_X}$ | NO ACCESSIBLE NEUTRAL ON LOW WINDING |
|                           |                         |              | B     |                 | H <sub>2</sub> - H <sub>1</sub> | X <sub>1</sub> - X <sub>2</sub> |                   |                           |                                      |
|                           |                         |              | C     |                 | H <sub>3</sub> - H <sub>2</sub> | X <sub>2</sub> - X <sub>3</sub> |                   |                           |                                      |
|                           |                         | Dz8          | A     |                 | H <sub>1</sub> - H <sub>3</sub> | X <sub>2</sub> - X <sub>1</sub> | $\frac{V_H}{V_X}$ | $3 \cdot \frac{V_H}{V_X}$ | NO ACCESSIBLE NEUTRAL ON LOW WINDING |
|                           |                         |              | B     |                 | H <sub>2</sub> - H <sub>1</sub> | X <sub>3</sub> - X <sub>2</sub> |                   |                           |                                      |
|                           |                         |              | C     |                 | H <sub>3</sub> - H <sub>2</sub> | X <sub>1</sub> - X <sub>3</sub> |                   |                           |                                      |

NOTES:

651VANGUARD080308V6

- 1) Meas Ratio is the ratio measured by the instrument, where V<sub>H</sub>, V<sub>X</sub>, are the Nameplate Voltages.
- 2) Turns Ratio is the physical ratio of the number of turns on the core, expressed in terms of V<sub>H</sub> and V<sub>X</sub>.

APPENDIX B (continued)

ANSI Transformers Description

| TRANSFORMER CONFIGURATION |                         | VECTOR GROUP | PHASE | WINDING TESTED                  |                                 |                                 | MEAS RATIO                          | TURNS RATIO                         | NOTES                                 |
|---------------------------|-------------------------|--------------|-------|---------------------------------|---------------------------------|---------------------------------|-------------------------------------|-------------------------------------|---------------------------------------|
| HIGH-VOLTAGE WINDING (H)  | LOW-VOLTAGE WINDING (X) |              |       | INTERNAL JUMPER                 | HIGH VOLTAGE WINDING            | LOW VOLTAGE WINDING             |                                     |                                     |                                       |
|                           |                         | Dz10         | A     |                                 | H <sub>1</sub> - H <sub>3</sub> | X <sub>2</sub> - X <sub>3</sub> | $\frac{V_H}{V_X}$                   | $3 \cdot \frac{V_H}{V_X}$           | NO ACCESSIBLE NEUTRAL ON LOW WINDING  |
|                           |                         |              | B     |                                 | H <sub>2</sub> - H <sub>1</sub> | X <sub>3</sub> - X <sub>1</sub> |                                     |                                     |                                       |
|                           |                         |              | C     |                                 | H <sub>3</sub> - H <sub>2</sub> | X <sub>1</sub> - X <sub>2</sub> |                                     |                                     |                                       |
|                           |                         | Dzn0         | A     | H <sub>1</sub> - H <sub>2</sub> | H <sub>1</sub> - H <sub>3</sub> | X <sub>0</sub> - X <sub>3</sub> | $\frac{3}{2} \cdot \frac{V_H}{V_X}$ | $3 \cdot \frac{V_H}{V_X}$           |                                       |
|                           |                         |              | B     | H <sub>2</sub> - H <sub>3</sub> | H <sub>2</sub> - H <sub>1</sub> | X <sub>0</sub> - X <sub>1</sub> |                                     |                                     |                                       |
|                           |                         |              | C     | H <sub>3</sub> - H <sub>1</sub> | H <sub>3</sub> - H <sub>2</sub> | X <sub>0</sub> - X <sub>2</sub> |                                     |                                     |                                       |
|                           |                         | Dzn2         | A     | H <sub>1</sub> - H <sub>2</sub> | H <sub>1</sub> - H <sub>3</sub> | X <sub>1</sub> - X <sub>0</sub> | $\frac{3}{2} \cdot \frac{V_H}{V_X}$ | $3 \cdot \frac{V_H}{V_X}$           |                                       |
|                           |                         |              | B     | H <sub>2</sub> - H <sub>3</sub> | H <sub>2</sub> - H <sub>1</sub> | X <sub>2</sub> - X <sub>0</sub> |                                     |                                     |                                       |
|                           |                         |              | C     | H <sub>3</sub> - H <sub>1</sub> | H <sub>3</sub> - H <sub>2</sub> | X <sub>3</sub> - X <sub>0</sub> |                                     |                                     |                                       |
|                           |                         | Dzn4         | A     | H <sub>1</sub> - H <sub>2</sub> | H <sub>1</sub> - H <sub>3</sub> | X <sub>0</sub> - X <sub>2</sub> | $\frac{3}{2} \cdot \frac{V_H}{V_X}$ | $3 \cdot \frac{V_H}{V_X}$           |                                       |
|                           |                         |              | B     | H <sub>2</sub> - H <sub>3</sub> | H <sub>2</sub> - H <sub>1</sub> | X <sub>0</sub> - X <sub>3</sub> |                                     |                                     |                                       |
|                           |                         |              | C     | H <sub>3</sub> - H <sub>1</sub> | H <sub>3</sub> - H <sub>2</sub> | X <sub>0</sub> - X <sub>1</sub> |                                     |                                     |                                       |
|                           |                         | Dzn6         | A     | H <sub>1</sub> - H <sub>2</sub> | H <sub>1</sub> - H <sub>3</sub> | X <sub>3</sub> - X <sub>0</sub> | $\frac{3}{2} \cdot \frac{V_H}{V_X}$ | $3 \cdot \frac{V_H}{V_X}$           |                                       |
|                           |                         |              | B     | H <sub>2</sub> - H <sub>3</sub> | H <sub>2</sub> - H <sub>1</sub> | X <sub>1</sub> - X <sub>0</sub> |                                     |                                     |                                       |
|                           |                         |              | C     | H <sub>3</sub> - H <sub>1</sub> | H <sub>3</sub> - H <sub>2</sub> | X <sub>2</sub> - X <sub>0</sub> |                                     |                                     |                                       |
|                           |                         | Dzn8         | A     | H <sub>1</sub> - H <sub>2</sub> | H <sub>1</sub> - H <sub>3</sub> | X <sub>0</sub> - X <sub>1</sub> | $\frac{3}{2} \cdot \frac{V_H}{V_X}$ | $3 \cdot \frac{V_H}{V_X}$           |                                       |
|                           |                         |              | B     | H <sub>2</sub> - H <sub>3</sub> | H <sub>2</sub> - H <sub>1</sub> | X <sub>0</sub> - X <sub>2</sub> |                                     |                                     |                                       |
|                           |                         |              | C     | H <sub>3</sub> - H <sub>1</sub> | H <sub>3</sub> - H <sub>2</sub> | X <sub>0</sub> - X <sub>3</sub> |                                     |                                     |                                       |
|                           |                         | Dzn10        | A     | H <sub>1</sub> - H <sub>2</sub> | H <sub>1</sub> - H <sub>3</sub> | X <sub>2</sub> - X <sub>0</sub> | $\frac{3}{2} \cdot \frac{V_H}{V_X}$ | $3 \cdot \frac{V_H}{V_X}$           |                                       |
|                           |                         |              | B     | H <sub>2</sub> - H <sub>3</sub> | H <sub>2</sub> - H <sub>1</sub> | X <sub>3</sub> - X <sub>0</sub> |                                     |                                     |                                       |
|                           |                         |              | C     | H <sub>3</sub> - H <sub>1</sub> | H <sub>3</sub> - H <sub>2</sub> | X <sub>1</sub> - X <sub>0</sub> |                                     |                                     |                                       |
|                           |                         | Zd0          | A     |                                 | H <sub>1</sub> - H <sub>3</sub> | X <sub>1</sub> - X <sub>3</sub> | $\frac{V_H}{V_X}$                   | $\frac{1}{3} \cdot \frac{V_H}{V_X}$ | NO ACCESSIBLE NEUTRAL ON HIGH WINDING |
|                           |                         |              | B     |                                 | H <sub>2</sub> - H <sub>1</sub> | X <sub>2</sub> - X <sub>1</sub> |                                     |                                     |                                       |
|                           |                         |              | C     |                                 | H <sub>3</sub> - H <sub>2</sub> | X <sub>3</sub> - X <sub>2</sub> |                                     |                                     |                                       |
|                           |                         | Zd2          | A     |                                 | H <sub>1</sub> - H <sub>3</sub> | X <sub>1</sub> - X <sub>2</sub> | $\frac{V_H}{V_X}$                   | $\frac{1}{3} \cdot \frac{V_H}{V_X}$ | NO ACCESSIBLE NEUTRAL ON HIGH WINDING |
|                           |                         |              | B     |                                 | H <sub>2</sub> - H <sub>1</sub> | X <sub>2</sub> - X <sub>3</sub> |                                     |                                     |                                       |
|                           |                         |              | C     |                                 | H <sub>3</sub> - H <sub>2</sub> | X <sub>3</sub> - X <sub>1</sub> |                                     |                                     |                                       |
|                           |                         | Zd4          | A     |                                 | H <sub>1</sub> - H <sub>3</sub> | X <sub>3</sub> - X <sub>2</sub> | $\frac{V_H}{V_X}$                   | $\frac{1}{3} \cdot \frac{V_H}{V_X}$ | NO ACCESSIBLE NEUTRAL ON HIGH WINDING |
|                           |                         |              | B     |                                 | H <sub>2</sub> - H <sub>1</sub> | X <sub>1</sub> - X <sub>3</sub> |                                     |                                     |                                       |
|                           |                         |              | C     |                                 | H <sub>3</sub> - H <sub>2</sub> | X <sub>2</sub> - X <sub>1</sub> |                                     |                                     |                                       |

NOTES:

651VANGUARD080308V7

- 1) Meas Ratio is the ratio measured by the instrument, where V<sub>H</sub>, V<sub>X</sub>, are the Nameplate Voltages.
- 2) Turns Ratio is the physical ratio of the number of turns on the core, expressed in terms of V<sub>H</sub> and V<sub>X</sub>.

APPENDIX B (continued)

ANSI Transformers Description

| TRANSFORMER CONFIGURATION |                         | VECTOR GROUP | PHASE | WINDING TESTED                  |                                 |                                 | MEAS RATIO                                 | TURNS RATIO                                | NOTES                                 |
|---------------------------|-------------------------|--------------|-------|---------------------------------|---------------------------------|---------------------------------|--|--|---------------------------------------|
| HIGH-VOLTAGE WINDING (H)  | LOW-VOLTAGE WINDING (X) |              |       | INTERNAL JUMPER                 | HIGH VOLTAGE WINDING            | LOW VOLTAGE WINDING             |  |  |                                       |
|                           |                         | Zd6          | A     |                                 | H <sub>1</sub> - H <sub>3</sub> | X <sub>3</sub> - X <sub>1</sub> | $\frac{V_H}{V_X}$                          | $\frac{1}{3} \cdot \frac{V_H}{V_X}$        | NO ACCESSIBLE NEUTRAL ON HIGH WINDING |
|                           |                         |              | B     |                                 | H <sub>2</sub> - H <sub>1</sub> | X <sub>1</sub> - X <sub>2</sub> |  |  |                                       |
|                           |                         |              | C     |                                 | H <sub>3</sub> - H <sub>2</sub> | X <sub>2</sub> - X <sub>3</sub> |  |  |                                       |
|                           |                         | Zd8          | A     |                                 | H <sub>1</sub> - H <sub>3</sub> | X <sub>2</sub> - X <sub>1</sub> | $\frac{V_H}{V_X}$                          | $\frac{1}{3} \cdot \frac{V_H}{V_X}$        | NO ACCESSIBLE NEUTRAL ON HIGH WINDING |
|                           |                         |              | B     |                                 | H <sub>2</sub> - H <sub>1</sub> | X <sub>3</sub> - X <sub>2</sub> |  |  |                                       |
|                           |                         |              | C     |                                 | H <sub>3</sub> - H <sub>2</sub> | X <sub>1</sub> - X <sub>3</sub> |  |  |                                       |
|                           |                         | Zd10         | A     |                                 | H <sub>1</sub> - H <sub>3</sub> | X <sub>2</sub> - X <sub>3</sub> | $\frac{V_H}{V_X}$                          | $\frac{1}{3} \cdot \frac{V_H}{V_X}$        | NO ACCESSIBLE NEUTRAL ON HIGH WINDING |
|                           |                         |              | B     |                                 | H <sub>2</sub> - H <sub>1</sub> | X <sub>3</sub> - X <sub>1</sub> |  |  |                                       |
|                           |                         |              | C     |                                 | H <sub>3</sub> - H <sub>2</sub> | X <sub>1</sub> - X <sub>2</sub> |  |  |                                       |
|                           |                         | ZNd0         | A     | X <sub>2</sub> - X <sub>3</sub> | H <sub>1</sub> - H <sub>0</sub> | X <sub>1</sub> - X <sub>2</sub> | $\frac{2}{3} \cdot \frac{V_H}{V_X}$        | $\frac{1}{3} \cdot \frac{V_H}{V_X}$        |                                       |
|                           |                         |              | B     | X <sub>3</sub> - X <sub>1</sub> | H <sub>2</sub> - H <sub>0</sub> | X <sub>2</sub> - X <sub>3</sub> |  |  |                                       |
|                           |                         |              | C     | X <sub>1</sub> - X <sub>2</sub> | H <sub>3</sub> - H <sub>0</sub> | X <sub>3</sub> - X <sub>1</sub> |  |  |                                       |
|                           |                         | ZNd2         | A     | X <sub>3</sub> - X <sub>1</sub> | H <sub>1</sub> - H <sub>0</sub> | X <sub>3</sub> - X <sub>2</sub> | $\frac{2}{3} \cdot \frac{V_H}{V_X}$        | $\frac{1}{3} \cdot \frac{V_H}{V_X}$        |                                       |
|                           |                         |              | B     | X <sub>1</sub> - X <sub>2</sub> | H <sub>2</sub> - H <sub>0</sub> | X <sub>1</sub> - X <sub>3</sub> |  |  |                                       |
|                           |                         |              | C     | X <sub>2</sub> - X <sub>3</sub> | H <sub>3</sub> - H <sub>0</sub> | X <sub>2</sub> - X <sub>1</sub> |  |  |                                       |
|                           |                         | ZNd4         | A     | X <sub>1</sub> - X <sub>2</sub> | H <sub>1</sub> - H <sub>0</sub> | X <sub>3</sub> - X <sub>1</sub> | $\frac{2}{3} \cdot \frac{V_H}{V_X}$        | $\frac{1}{3} \cdot \frac{V_H}{V_X}$        |                                       |
|                           |                         |              | B     | X <sub>2</sub> - X <sub>3</sub> | H <sub>2</sub> - H <sub>0</sub> | X <sub>1</sub> - X <sub>2</sub> |  |  |                                       |
|                           |                         |              | C     | X <sub>3</sub> - X <sub>1</sub> | H <sub>3</sub> - H <sub>0</sub> | X <sub>2</sub> - X <sub>3</sub> |  |  |                                       |
|                           |                         | ZNd6         | A     | X <sub>2</sub> - X <sub>3</sub> | H <sub>1</sub> - H <sub>0</sub> | X <sub>2</sub> - X <sub>1</sub> | $\frac{2}{3} \cdot \frac{V_H}{V_X}$        | $\frac{1}{3} \cdot \frac{V_H}{V_X}$        |                                       |
|                           |                         |              | B     | X <sub>3</sub> - X <sub>1</sub> | H <sub>2</sub> - H <sub>0</sub> | X <sub>3</sub> - X <sub>2</sub> |  |  |                                       |
|                           |                         |              | C     | X <sub>1</sub> - X <sub>2</sub> | H <sub>3</sub> - H <sub>0</sub> | X <sub>1</sub> - X <sub>3</sub> |  |  |                                       |
|                           |                         | ZNd8         | A     | X <sub>3</sub> - X <sub>1</sub> | H <sub>1</sub> - H <sub>0</sub> | X <sub>2</sub> - X <sub>3</sub> | $\frac{2}{3} \cdot \frac{V_H}{V_X}$        | $\frac{1}{3} \cdot \frac{V_H}{V_X}$        |                                       |
|                           |                         |              | B     | X <sub>1</sub> - X <sub>2</sub> | H <sub>2</sub> - H <sub>0</sub> | X <sub>3</sub> - X <sub>1</sub> |  |  |                                       |
|                           |                         |              | C     | X <sub>2</sub> - X <sub>3</sub> | H <sub>3</sub> - H <sub>0</sub> | X <sub>1</sub> - X <sub>2</sub> |  |  |                                       |
|                           |                         | ZNd10        | A     | X <sub>1</sub> - X <sub>2</sub> | H <sub>1</sub> - H <sub>0</sub> | X <sub>1</sub> - X <sub>3</sub> | $\frac{2}{3} \cdot \frac{V_H}{V_X}$        | $\frac{1}{3} \cdot \frac{V_H}{V_X}$        |                                       |
|                           |                         |              | B     | X <sub>2</sub> - X <sub>3</sub> | H <sub>2</sub> - H <sub>0</sub> | X <sub>2</sub> - X <sub>1</sub> |  |  |                                       |
|                           |                         |              | C     | X <sub>3</sub> - X <sub>1</sub> | H <sub>3</sub> - H <sub>0</sub> | X <sub>3</sub> - X <sub>2</sub> |  |  |                                       |
|                           |                         | Yz1          | A     | X <sub>3</sub> - X <sub>2</sub> | H <sub>1</sub> - H <sub>3</sub> | X <sub>1</sub> - X <sub>2</sub> | $\frac{V_H}{V_X} \cdot \frac{\sqrt{3}}{2}$ | $\frac{V_H}{V_X} \cdot \frac{\sqrt{3}}{2}$ | NO ACCESSIBLE NEUTRAL                 |
|                           |                         |              | B     | X <sub>1</sub> - X <sub>3</sub> | H <sub>2</sub> - H <sub>1</sub> | X <sub>2</sub> - X <sub>3</sub> |  |  |                                       |
|                           |                         |              | C     | X <sub>2</sub> - X <sub>1</sub> | H <sub>3</sub> - H <sub>2</sub> | X <sub>3</sub> - X <sub>1</sub> |  |  |                                       |

NOTES:

651VANGUARD080308V8

- 1) Meas Ratio is the ratio measured by the instrument, where V<sub>H</sub>, V<sub>X</sub>, are the Nameplate Voltages.
- 2) Turns Ratio is the physical ratio of the number of turns on the core, expressed in terms of V<sub>H</sub> and V<sub>X</sub>.

APPENDIX B (continued)

ANSI Transformers Description

| TRANSFORMER CONFIGURATION |                         | VECTOR GROUP | PHASE | WINDING TESTED  |                      |                     | MEAS RATIO                                 | TURNS RATIO                      | NOTES                                |
|---------------------------|-------------------------|--------------|-------|-----------------|----------------------|---------------------|--|----------------------------------|--------------------------------------|
| HIGH-VOLTAGE WINDING (H)  | LOW-VOLTAGE WINDING (X) |              |       | INTERNAL JUMPER | HIGH VOLTAGE WINDING | LOW VOLTAGE WINDING |  |                                  |                                      |
|                           |                         | Yz3          | A     | H3-H2           | H1-H3                | X3-X2               | $\frac{V_H}{V_X} \cdot \frac{\sqrt{3}}{2}$ | $\frac{V_H}{V_X} \cdot \sqrt{3}$ | NO ACCESSIBLE NEUTRAL                |
|                           |                         |              | B     | H1-H3           | H2-H1                | X1-X3               |  |                                  |                                      |
|                           |                         |              | C     | H2-H1           | H3-H2                | X2-X1               |  |                                  |                                      |
|                           |                         | Yz5          | A     | H3-H2           | H1-H3                | X3-X1               | $\frac{V_H}{V_X} \cdot \frac{\sqrt{3}}{2}$ | $\frac{V_H}{V_X} \cdot \sqrt{3}$ | NO ACCESSIBLE NEUTRAL                |
|                           |                         |              | B     | H1-H3           | H2-H1                | X1-X2               |  |                                  |                                      |
|                           |                         |              | C     | H2-H1           | H3-H2                | X2-X3               |  |                                  |                                      |
|                           |                         | Yz7          | A     | H3-H2           | H1-H3                | X2-X1               | $\frac{V_H}{V_X} \cdot \frac{\sqrt{3}}{2}$ | $\frac{V_H}{V_X} \cdot \sqrt{3}$ | NO ACCESSIBLE NEUTRAL                |
|                           |                         |              | B     | H1-H3           | H2-H1                | X3-X2               |  |                                  |                                      |
|                           |                         |              | C     | H2-H1           | H3-H2                | X1-X3               |  |                                  |                                      |
|                           |                         | Yz9          | A     | H3-H2           | H1-H3                | X2-X3               | $\frac{V_H}{V_X} \cdot \frac{\sqrt{3}}{2}$ | $\frac{V_H}{V_X} \cdot \sqrt{3}$ | NO ACCESSIBLE NEUTRAL                |
|                           |                         |              | B     | H1-H3           | H2-H1                | X3-X1               |  |                                  |                                      |
|                           |                         |              | C     | H2-H1           | H3-H2                | X1-X2               |  |                                  |                                      |
|                           |                         | Yz11         | A     | H3-H2           | H1-H3                | X1-X3               | $\frac{V_H}{V_X} \cdot \frac{\sqrt{3}}{2}$ | $\frac{V_H}{V_X} \cdot \sqrt{3}$ | NO ACCESSIBLE NEUTRAL                |
|                           |                         |              | B     | H1-H3           | H2-H1                | X2-X1               |  |                                  |                                      |
|                           |                         |              | C     | H2-H1           | H3-H2                | X3-X2               |  |                                  |                                      |
|                           |                         | YNz1         | A     | H3-H2           | H1-H3                | X1-X2               | $\frac{V_H}{V_X} \cdot \frac{\sqrt{3}}{2}$ | $\frac{V_H}{V_X} \cdot \sqrt{3}$ | NO ACCESSIBLE NEUTRAL ON LOW WINDING |
|                           |                         |              | B     | H1-H3           | H2-H1                | X2-X3               |  |                                  |                                      |
|                           |                         |              | C     | H2-H1           | H3-H2                | X3-X1               |  |                                  |                                      |
|                           |                         | YNz3         | A     | H3-H2           | H1-H3                | X3-X2               | $\frac{V_H}{V_X} \cdot \frac{\sqrt{3}}{2}$ | $\frac{V_H}{V_X} \cdot \sqrt{3}$ | NO ACCESSIBLE NEUTRAL ON LOW WINDING |
|                           |                         |              | B     | H1-H3           | H2-H1                | X1-X3               |  |                                  |                                      |
|                           |                         |              | C     | H2-H1           | H3-H2                | X2-X1               |  |                                  |                                      |
|                           |                         | YNz5         | A     | H3-H2           | H1-H3                | X3-X1               | $\frac{V_H}{V_X} \cdot \frac{\sqrt{3}}{2}$ | $\frac{V_H}{V_X} \cdot \sqrt{3}$ | NO ACCESSIBLE NEUTRAL ON LOW WINDING |
|                           |                         |              | B     | H1-H3           | H2-H1                | X1-X2               |  |                                  |                                      |
|                           |                         |              | C     | H2-H1           | H3-H2                | X2-X3               |  |                                  |                                      |
|                           |                         | YNz7         | A     | H3-H2           | H1-H3                | X2-X1               | $\frac{V_H}{V_X} \cdot \frac{\sqrt{3}}{2}$ | $\frac{V_H}{V_X} \cdot \sqrt{3}$ | NO ACCESSIBLE NEUTRAL ON LOW WINDING |
|                           |                         |              | B     | H1-H3           | H2-H1                | X3-X2               |  |                                  |                                      |
|                           |                         |              | C     | H2-H1           | H3-H2                | X1-X3               |  |                                  |                                      |
|                           |                         | YNz9         | A     | H3-H2           | H1-H3                | X2-X3               | $\frac{V_H}{V_X} \cdot \frac{\sqrt{3}}{2}$ | $\frac{V_H}{V_X} \cdot \sqrt{3}$ | NO ACCESSIBLE NEUTRAL ON LOW WINDING |
|                           |                         |              | B     | H1-H3           | H2-H1                | X3-X1               |  |                                  |                                      |
|                           |                         |              | C     | H2-H1           | H3-H2                | X1-X2               |  |                                  |                                      |

NOTES:

651VANGUARD080308V9

- 1) Meas Ratio is the ratio measured by the instrument, where  $V_h$ ,  $V_x$ , are the Nameplate Voltages.
- 2) Turns Ratio is the physical ratio of the number of turns on the core, expressed in terms of  $V_h$  and  $V_x$ .

APPENDIX B (continued)

ANSI Transformers Description

| TRANSFORMER CONFIGURATION |                         | VECTOR GROUP | PHASE | WINDING TESTED                  |                                 |                                 | MEAS RATIO                                 | TURNS RATIO                      | NOTES                                 |
|---------------------------|-------------------------|--------------|-------|---------------------------------|---------------------------------|---------------------------------|--|----------------------------------|---------------------------------------|
| HIGH-VOLTAGE WINDING (H)  | LOW-VOLTAGE WINDING (X) |              |       | INTERNAL JUMPER                 | HIGH VOLTAGE WINDING            | LOW VOLTAGE WINDING             |  |                                  |                                       |
|                           |                         | YNzn11       | A     | H <sub>3</sub> - H <sub>2</sub> | H <sub>1</sub> - H <sub>3</sub> | X <sub>1</sub> - X <sub>3</sub> | $\frac{V_H}{V_X} \cdot \frac{\sqrt{3}}{2}$ | $\frac{V_H}{V_X} \cdot \sqrt{3}$ | NO ACCESSIBLE NEUTRAL ON LOW WINDING  |
|                           |                         |              | B     | H <sub>1</sub> - H <sub>3</sub> | H <sub>2</sub> - H <sub>1</sub> | X <sub>2</sub> - X <sub>1</sub> |  |                                  |                                       |
|                           |                         |              | C     | H <sub>2</sub> - H <sub>1</sub> | H <sub>3</sub> - H <sub>2</sub> | X <sub>3</sub> - X <sub>2</sub> |  |                                  |                                       |
|                           |                         | Yzn1         | A     |                                 | H <sub>1</sub> - H <sub>3</sub> | X <sub>1</sub> - X <sub>0</sub> | $\frac{V_H}{V_X} \cdot \sqrt{3}$           | $\frac{V_H}{V_X} \cdot \sqrt{3}$ | NO ACCESSIBLE NEUTRAL ON HIGH WINDING |
|                           |                         |              | B     |                                 | H <sub>2</sub> - H <sub>1</sub> | X <sub>2</sub> - X <sub>0</sub> |  |                                  |                                       |
|                           |                         |              | C     |                                 | H <sub>3</sub> - H <sub>2</sub> | X <sub>3</sub> - X <sub>0</sub> |  |                                  |                                       |
|                           |                         | Yzn3         | A     |                                 | H <sub>1</sub> - H <sub>3</sub> | X <sub>0</sub> - X <sub>2</sub> | $\frac{V_H}{V_X} \cdot \sqrt{3}$           | $\frac{V_H}{V_X} \cdot \sqrt{3}$ | NO ACCESSIBLE NEUTRAL ON HIGH WINDING |
|                           |                         |              | B     |                                 | H <sub>2</sub> - H <sub>1</sub> | X <sub>0</sub> - X <sub>3</sub> |  |                                  |                                       |
|                           |                         |              | C     |                                 | H <sub>3</sub> - H <sub>2</sub> | X <sub>0</sub> - X <sub>1</sub> |  |                                  |                                       |
|                           |                         | Yzn5         | A     |                                 | H <sub>1</sub> - H <sub>3</sub> | X <sub>3</sub> - X <sub>0</sub> | $\frac{V_H}{V_X} \cdot \sqrt{3}$           | $\frac{V_H}{V_X} \cdot \sqrt{3}$ | NO ACCESSIBLE NEUTRAL ON HIGH WINDING |
|                           |                         |              | B     |                                 | H <sub>2</sub> - H <sub>1</sub> | X <sub>1</sub> - X <sub>0</sub> |  |                                  |                                       |
|                           |                         |              | C     |                                 | H <sub>3</sub> - H <sub>2</sub> | X <sub>2</sub> - X <sub>0</sub> |  |                                  |                                       |
|                           |                         | Yzn7         | A     |                                 | H <sub>1</sub> - H <sub>3</sub> | X <sub>0</sub> - X <sub>1</sub> | $\frac{V_H}{V_X} \cdot \sqrt{3}$           | $\frac{V_H}{V_X} \cdot \sqrt{3}$ | NO ACCESSIBLE NEUTRAL ON HIGH WINDING |
|                           |                         |              | B     |                                 | H <sub>2</sub> - H <sub>1</sub> | X <sub>0</sub> - X <sub>2</sub> |  |                                  |                                       |
|                           |                         |              | C     |                                 | H <sub>3</sub> - H <sub>2</sub> | X <sub>0</sub> - X <sub>3</sub> |  |                                  |                                       |
|                           |                         | Yyn9         | A     |                                 | H <sub>1</sub> - H <sub>3</sub> | X <sub>2</sub> - X <sub>0</sub> | $\frac{V_H}{V_X} \cdot \sqrt{3}$           | $\frac{V_H}{V_X} \cdot \sqrt{3}$ | NO ACCESSIBLE NEUTRAL ON HIGH WINDING |
|                           |                         |              | B     |                                 | H <sub>2</sub> - H <sub>1</sub> | X <sub>3</sub> - X <sub>0</sub> |  |                                  |                                       |
|                           |                         |              | C     |                                 | H <sub>3</sub> - H <sub>2</sub> | X <sub>1</sub> - X <sub>0</sub> |  |                                  |                                       |
|                           |                         | Yzn11        | A     |                                 | H <sub>1</sub> - H <sub>3</sub> | X <sub>0</sub> - X <sub>3</sub> | $\frac{V_H}{V_X} \cdot \sqrt{3}$           | $\frac{V_H}{V_X} \cdot \sqrt{3}$ | NO ACCESSIBLE NEUTRAL ON HIGH WINDING |
|                           |                         |              | B     |                                 | H <sub>2</sub> - H <sub>1</sub> | X <sub>0</sub> - X <sub>1</sub> |  |                                  |                                       |
|                           |                         |              | C     |                                 | H <sub>3</sub> - H <sub>2</sub> | X <sub>0</sub> - X <sub>2</sub> |  |                                  |                                       |
|                           |                         | YNzn1        | A     |                                 | H <sub>1</sub> - H <sub>3</sub> | X <sub>1</sub> - X <sub>0</sub> | $\frac{V_H}{V_X} \cdot \sqrt{3}$           | $\frac{V_H}{V_X} \cdot \sqrt{3}$ |                                       |
|                           |                         |              | B     |                                 | H <sub>2</sub> - H <sub>1</sub> | X <sub>2</sub> - X <sub>0</sub> |  |                                  |                                       |
|                           |                         |              | C     |                                 | H <sub>3</sub> - H <sub>2</sub> | X <sub>3</sub> - X <sub>0</sub> |  |                                  |                                       |
|                           |                         | YNzn3        | A     |                                 | H <sub>1</sub> - H <sub>3</sub> | X <sub>0</sub> - X <sub>2</sub> | $\frac{V_H}{V_X} \cdot \sqrt{3}$           | $\frac{V_H}{V_X} \cdot \sqrt{3}$ |                                       |
|                           |                         |              | B     |                                 | H <sub>2</sub> - H <sub>1</sub> | X <sub>0</sub> - X <sub>3</sub> |  |                                  |                                       |
|                           |                         |              | C     |                                 | H <sub>3</sub> - H <sub>2</sub> | X <sub>0</sub> - X <sub>1</sub> |  |                                  |                                       |
|                           |                         | YNzn5        | A     |                                 | H <sub>1</sub> - H <sub>3</sub> | X <sub>3</sub> - X <sub>0</sub> | $\frac{V_H}{V_X} \cdot \sqrt{3}$           | $\frac{V_H}{V_X} \cdot \sqrt{3}$ |                                       |
|                           |                         |              | B     |                                 | H <sub>2</sub> - H <sub>1</sub> | X <sub>1</sub> - X <sub>0</sub> |  |                                  |                                       |
|                           |                         |              | C     |                                 | H <sub>3</sub> - H <sub>2</sub> | X <sub>2</sub> - X <sub>0</sub> |  |                                  |                                       |

NOTES:

651VANGUARD080308V10

1) Meas Ratio is the ratio measured by the instrument, where V<sub>H</sub>, V<sub>X</sub>, are the Nameplate Voltages.

2) Turns Ratio is the physical ratio of the number of turns on the core, expressed in terms of V<sub>H</sub> and V<sub>X</sub>.

APPENDIX B (continued)

ANSI Transformers Description

| TRANSFORMER CONFIGURATION |                         | VECTOR GROUP | PHASE | WINDING TESTED                  |                                 |                                 | MEAS RATIO                                 | TURNS RATIO                      | NOTES                                |
|---------------------------|-------------------------|--------------|-------|---------------------------------|---------------------------------|---------------------------------|--|----------------------------------|--------------------------------------|
| HIGH-VOLTAGE WINDING (H)  | LOW-VOLTAGE WINDING (X) |              |       | INTERNAL JUMPER                 | HIGH VOLTAGE WINDING            | LOW VOLTAGE WINDING             |  |                                  |                                      |
|                           |                         | YNzn7        | A     |                                 | H <sub>1</sub> - H <sub>3</sub> | X <sub>0</sub> - X <sub>1</sub> | $\frac{V_H}{V_X} \cdot \sqrt{3}$           | $\frac{V_H}{V_X} \cdot \sqrt{3}$ |                                      |
|                           |                         |              | B     |                                 | H <sub>2</sub> - H <sub>1</sub> | X <sub>0</sub> - X <sub>2</sub> |  |                                  |                                      |
|                           |                         |              | C     |                                 | H <sub>3</sub> - H <sub>2</sub> | X <sub>0</sub> - X <sub>3</sub> |  |                                  |                                      |
|                           |                         | YNzn9        | A     |                                 | H <sub>1</sub> - H <sub>3</sub> | X <sub>2</sub> - X <sub>0</sub> | $\frac{V_H}{V_X} \cdot \sqrt{3}$           | $\frac{V_H}{V_X} \cdot \sqrt{3}$ |                                      |
|                           |                         |              | B     |                                 | H <sub>2</sub> - H <sub>1</sub> | X <sub>3</sub> - X <sub>0</sub> |  |                                  |                                      |
|                           |                         |              | C     |                                 | H <sub>3</sub> - H <sub>2</sub> | X <sub>1</sub> - X <sub>0</sub> |  |                                  |                                      |
|                           |                         | YNzn11       | A     |                                 | H <sub>1</sub> - H <sub>3</sub> | X <sub>0</sub> - X <sub>3</sub> | $\frac{V_H}{V_X} \cdot \sqrt{3}$           | $\frac{V_H}{V_X} \cdot \sqrt{3}$ |                                      |
|                           |                         |              | B     |                                 | H <sub>2</sub> - H <sub>1</sub> | X <sub>0</sub> - X <sub>1</sub> |  |                                  |                                      |
|                           |                         |              | C     |                                 | H <sub>3</sub> - H <sub>2</sub> | X <sub>0</sub> - X <sub>2</sub> |  |                                  |                                      |
|                           |                         | Zy1          | A     | H <sub>3</sub> - H <sub>2</sub> | H <sub>1</sub> - H <sub>3</sub> | X <sub>1</sub> - X <sub>2</sub> | $\frac{V_H}{V_X} \cdot \frac{\sqrt{3}}{2}$ | $\frac{V_H}{V_X \cdot \sqrt{3}}$ | NO ACCESSIBLE NEUTRAL                |
|                           |                         |              | B     | H <sub>1</sub> - H <sub>3</sub> | H <sub>2</sub> - H <sub>1</sub> | X <sub>2</sub> - X <sub>3</sub> |  |                                  |                                      |
|                           |                         |              | C     | H <sub>3</sub> - H <sub>1</sub> | H <sub>3</sub> - H <sub>2</sub> | X <sub>3</sub> - X <sub>1</sub> |  |                                  |                                      |
|                           |                         | Zy3          | A     | H <sub>3</sub> - H <sub>2</sub> | H <sub>1</sub> - H <sub>3</sub> | X <sub>3</sub> - X <sub>2</sub> | $\frac{V_H}{V_X} \cdot \frac{\sqrt{3}}{2}$ | $\frac{V_H}{V_X \cdot \sqrt{3}}$ | NO ACCESSIBLE NEUTRAL                |
|                           |                         |              | B     | H <sub>1</sub> - H <sub>3</sub> | H <sub>2</sub> - H <sub>1</sub> | X <sub>1</sub> - X <sub>3</sub> |  |                                  |                                      |
|                           |                         |              | C     | H <sub>2</sub> - H <sub>1</sub> | H <sub>3</sub> - H <sub>2</sub> | X <sub>2</sub> - X <sub>1</sub> |  |                                  |                                      |
|                           |                         | Zy5          | A     | H <sub>3</sub> - H <sub>2</sub> | H <sub>1</sub> - H <sub>3</sub> | X <sub>3</sub> - X <sub>1</sub> | $\frac{V_H}{V_X} \cdot \frac{\sqrt{3}}{2}$ | $\frac{V_H}{V_X \cdot \sqrt{3}}$ | NO ACCESSIBLE NEUTRAL                |
|                           |                         |              | B     | H <sub>1</sub> - H <sub>3</sub> | H <sub>2</sub> - H <sub>1</sub> | X <sub>1</sub> - X <sub>2</sub> |  |                                  |                                      |
|                           |                         |              | C     | H <sub>2</sub> - H <sub>1</sub> | H <sub>3</sub> - H <sub>2</sub> | X <sub>2</sub> - X <sub>3</sub> |  |                                  |                                      |
|                           |                         | Zy7          | A     | H <sub>3</sub> - H <sub>2</sub> | H <sub>1</sub> - H <sub>3</sub> | X <sub>2</sub> - X <sub>1</sub> | $\frac{V_H}{V_X} \cdot \frac{\sqrt{3}}{2}$ | $\frac{V_H}{V_X \cdot \sqrt{3}}$ | NO ACCESSIBLE NEUTRAL                |
|                           |                         |              | B     | H <sub>1</sub> - H <sub>3</sub> | H <sub>2</sub> - H <sub>1</sub> | X <sub>3</sub> - X <sub>2</sub> |  |                                  |                                      |
|                           |                         |              | C     | H <sub>2</sub> - H <sub>1</sub> | H <sub>3</sub> - H <sub>2</sub> | X <sub>1</sub> - X <sub>3</sub> |  |                                  |                                      |
|                           |                         | Zy9          | A     | H <sub>3</sub> - H <sub>2</sub> | H <sub>1</sub> - H <sub>3</sub> | X <sub>2</sub> - X <sub>3</sub> | $\frac{V_H}{V_X} \cdot \frac{\sqrt{3}}{2}$ | $\frac{V_H}{V_X \cdot \sqrt{3}}$ | NO ACCESSIBLE NEUTRAL                |
|                           |                         |              | B     | H <sub>1</sub> - H <sub>3</sub> | H <sub>2</sub> - H <sub>1</sub> | X <sub>3</sub> - X <sub>1</sub> |  |                                  |                                      |
|                           |                         |              | C     | H <sub>2</sub> - H <sub>1</sub> | H <sub>3</sub> - H <sub>2</sub> | X <sub>1</sub> - X <sub>2</sub> |  |                                  |                                      |
|                           |                         | Zy11         | A     | H <sub>3</sub> - H <sub>2</sub> | H <sub>1</sub> - H <sub>3</sub> | X <sub>1</sub> - X <sub>3</sub> | $\frac{V_H}{V_X} \cdot \frac{\sqrt{3}}{2}$ | $\frac{V_H}{V_X \cdot \sqrt{3}}$ | NO ACCESSIBLE NEUTRAL                |
|                           |                         |              | B     | H <sub>1</sub> - H <sub>3</sub> | H <sub>2</sub> - H <sub>1</sub> | X <sub>2</sub> - X <sub>1</sub> |  |                                  |                                      |
|                           |                         |              | C     | H <sub>2</sub> - H <sub>1</sub> | H <sub>3</sub> - H <sub>2</sub> | X <sub>3</sub> - X <sub>2</sub> |  |                                  |                                      |
|                           |                         | ZNy1         | A     |                                 | H <sub>1</sub> - H <sub>0</sub> | X <sub>1</sub> - X <sub>2</sub> | $\frac{V_H}{V_X \cdot \sqrt{3}}$           | $\frac{V_H}{V_X \cdot \sqrt{3}}$ | NO ACCESSIBLE NEUTRAL ON LOW WINDING |
|                           |                         |              | B     |                                 | H <sub>2</sub> - H <sub>0</sub> | X <sub>2</sub> - X <sub>3</sub> |  |                                  |                                      |
|                           |                         |              | C     |                                 | H <sub>3</sub> - H <sub>0</sub> | X <sub>3</sub> - X <sub>1</sub> |  |                                  |                                      |

NOTES:

651VANGUARD080308V11

- 1) Meas Ratio is the ratio measured by the instrument, where V<sub>H</sub>, V<sub>X</sub>, are the Nameplate Voltages.
- 2) Turns Ratio is the physical ratio of the number of turns on the core, expressed in terms of V<sub>H</sub> and V<sub>X</sub>.



APPENDIX B (continued)

ANSI Transformers Description

| TRANSFORMER CONFIGURATION |                         | VECTOR GROUP | PHASE | WINDING TESTED                  |                                 |                                 | MEAS RATIO                               | TURNS RATIO                      | NOTES                                 |
|---------------------------|-------------------------|--------------|-------|---------------------------------|---------------------------------|---------------------------------|--|----------------------------------|---------------------------------------|
| HIGH-VOLTAGE WINDING (H)  | LOW-VOLTAGE WINDING (X) |              |       | INTERNAL JUMPER                 | HIGH VOLTAGE WINDING            | LOW VOLTAGE WINDING             |  |                                  |                                       |
|                           |                         | ZNy3         | A     |                                 | H <sub>1</sub> - H <sub>0</sub> | X <sub>3</sub> - X <sub>2</sub> | $\frac{V_H}{V_X \cdot \sqrt{3}}$         | $\frac{V_H}{V_X \cdot \sqrt{3}}$ | NO ACCESSIBLE NEUTRAL ON LOW WINDING  |
|                           |                         |              | B     |                                 | H <sub>2</sub> - H <sub>0</sub> | X <sub>1</sub> - X <sub>3</sub> |  |                                  |                                       |
|                           |                         |              | C     |                                 | H <sub>3</sub> - H <sub>0</sub> | X <sub>2</sub> - X <sub>1</sub> |  |                                  |                                       |
|                           |                         | ZNy5         | A     |                                 | H <sub>1</sub> - H <sub>0</sub> | X <sub>3</sub> - X <sub>1</sub> | $\frac{V_H}{V_X \cdot \sqrt{3}}$         | $\frac{V_H}{V_X \cdot \sqrt{3}}$ | NO ACCESSIBLE NEUTRAL ON LOW WINDING  |
|                           |                         |              | B     |                                 | H <sub>2</sub> - H <sub>0</sub> | X <sub>1</sub> - X <sub>2</sub> |  |                                  |                                       |
|                           |                         |              | C     |                                 | H <sub>3</sub> - H <sub>0</sub> | X <sub>2</sub> - X <sub>3</sub> |  |                                  |                                       |
|                           |                         | ZNy7         | A     |                                 | H <sub>1</sub> - H <sub>0</sub> | X <sub>2</sub> - X <sub>1</sub> | $\frac{V_H}{V_X \cdot \sqrt{3}}$         | $\frac{V_H}{V_X \cdot \sqrt{3}}$ | NO ACCESSIBLE NEUTRAL ON LOW WINDING  |
|                           |                         |              | B     |                                 | H <sub>2</sub> - H <sub>0</sub> | X <sub>3</sub> - X <sub>2</sub> |  |                                  |                                       |
|                           |                         |              | C     |                                 | H <sub>3</sub> - H <sub>0</sub> | X <sub>1</sub> - X <sub>3</sub> |  |                                  |                                       |
|                           |                         | ZNy9         | A     |                                 | H <sub>1</sub> - H <sub>0</sub> | X <sub>2</sub> - X <sub>3</sub> | $\frac{V_H}{V_X \cdot \sqrt{3}}$         | $\frac{V_H}{V_X \cdot \sqrt{3}}$ | NO ACCESSIBLE NEUTRAL ON LOW WINDING  |
|                           |                         |              | B     |                                 | H <sub>2</sub> - H <sub>0</sub> | X <sub>3</sub> - X <sub>1</sub> |  |                                  |                                       |
|                           |                         |              | C     |                                 | H <sub>3</sub> - H <sub>0</sub> | X <sub>1</sub> - X <sub>2</sub> |  |                                  |                                       |
|                           |                         | ZNy11        | A     |                                 | H <sub>1</sub> - H <sub>0</sub> | X <sub>1</sub> - X <sub>3</sub> | $\frac{V_H}{V_X \cdot \sqrt{3}}$         | $\frac{V_H}{V_X \cdot \sqrt{3}}$ | NO ACCESSIBLE NEUTRAL ON LOW WINDING  |
|                           |                         |              | B     |                                 | H <sub>2</sub> - H <sub>0</sub> | X <sub>2</sub> - X <sub>1</sub> |  |                                  |                                       |
|                           |                         |              | C     |                                 | H <sub>3</sub> - H <sub>0</sub> | X <sub>3</sub> - X <sub>2</sub> |  |                                  |                                       |
|                           |                         | Zyn1         | A     | H <sub>3</sub> - H <sub>2</sub> | H <sub>1</sub> - H <sub>3</sub> | X <sub>1</sub> - X <sub>2</sub> | $\frac{V_H \cdot \sqrt{3}}{V_X \cdot 2}$ | $\frac{V_H}{V_X \cdot \sqrt{3}}$ | NO ACCESSIBLE NEUTRAL ON HIGH WINDING |
|                           |                         |              | B     | H <sub>1</sub> - H <sub>3</sub> | H <sub>2</sub> - H <sub>1</sub> | X <sub>2</sub> - X <sub>3</sub> |  |                                  |                                       |
|                           |                         |              | C     | H <sub>2</sub> - H <sub>1</sub> | H <sub>3</sub> - H <sub>2</sub> | X <sub>3</sub> - X <sub>1</sub> |  |                                  |                                       |
|                           |                         | Zyn3         | A     | H <sub>3</sub> - H <sub>2</sub> | H <sub>1</sub> - H <sub>3</sub> | X <sub>3</sub> - X <sub>2</sub> | $\frac{V_H \cdot \sqrt{3}}{V_X \cdot 2}$ | $\frac{V_H}{V_X \cdot \sqrt{3}}$ | NO ACCESSIBLE NEUTRAL ON HIGH WINDING |
|                           |                         |              | B     | H <sub>1</sub> - H <sub>3</sub> | H <sub>2</sub> - H <sub>1</sub> | X <sub>1</sub> - X <sub>3</sub> |  |                                  |                                       |
|                           |                         |              | C     | H <sub>2</sub> - H <sub>1</sub> | H <sub>3</sub> - H <sub>2</sub> | X <sub>2</sub> - X <sub>1</sub> |  |                                  |                                       |
|                           |                         | Zyn5         | A     | H <sub>3</sub> - H <sub>2</sub> | H <sub>1</sub> - H <sub>3</sub> | X <sub>3</sub> - X <sub>1</sub> | $\frac{V_H \cdot \sqrt{3}}{V_X \cdot 2}$ | $\frac{V_H}{V_X \cdot \sqrt{3}}$ | NO ACCESSIBLE NEUTRAL ON HIGH WINDING |
|                           |                         |              | B     | H <sub>1</sub> - H <sub>3</sub> | H <sub>2</sub> - H <sub>1</sub> | X <sub>1</sub> - X <sub>2</sub> |  |                                  |                                       |
|                           |                         |              | C     | H <sub>2</sub> - H <sub>1</sub> | H <sub>3</sub> - H <sub>2</sub> | X <sub>2</sub> - X <sub>3</sub> |  |                                  |                                       |
|                           |                         | Zyn7         | A     | H <sub>3</sub> - H <sub>2</sub> | H <sub>1</sub> - H <sub>3</sub> | X <sub>2</sub> - X <sub>1</sub> | $\frac{V_H \cdot \sqrt{3}}{V_X \cdot 2}$ | $\frac{V_H}{V_X \cdot \sqrt{3}}$ | NO ACCESSIBLE NEUTRAL ON HIGH WINDING |
|                           |                         |              | B     | H <sub>1</sub> - H <sub>3</sub> | H <sub>2</sub> - H <sub>1</sub> | X <sub>3</sub> - X <sub>2</sub> |  |                                  |                                       |
|                           |                         |              | C     | H <sub>2</sub> - H <sub>1</sub> | H <sub>3</sub> - H <sub>2</sub> | X <sub>1</sub> - X <sub>3</sub> |  |                                  |                                       |
|                           |                         | Zyn9         | A     | H <sub>3</sub> - H <sub>2</sub> | H <sub>1</sub> - H <sub>3</sub> | X <sub>2</sub> - X <sub>3</sub> | $\frac{V_H \cdot \sqrt{3}}{V_X \cdot 2}$ | $\frac{V_H}{V_X \cdot \sqrt{3}}$ | NO ACCESSIBLE NEUTRAL ON HIGH WINDING |
|                           |                         |              | B     | H <sub>1</sub> - H <sub>3</sub> | H <sub>2</sub> - H <sub>1</sub> | X <sub>3</sub> - X <sub>1</sub> |  |                                  |                                       |
|                           |                         |              | C     | H <sub>2</sub> - H <sub>1</sub> | H <sub>3</sub> - H <sub>2</sub> | X <sub>1</sub> - X <sub>2</sub> |  |                                  |                                       |

NOTES:

651VANGUARD080308V12

- 1) Meas Ratio is the ratio measured by the instrument, where V<sub>H</sub>, V<sub>X</sub>, are the Nameplate Voltages.
- 2) Turns Ratio is the physical ratio of the number of turns on the core, expressed in terms of V<sub>H</sub> and V<sub>X</sub>.

APPENDIX B (continued)

ANSI Transformers Description

| TRANSFORMER CONFIGURATION |                         | VECTOR GROUP     | PHASE | WINDING TESTED                  |                                 |                                 | MEAS RATIO                                 | TURNS RATIO                      | NOTES                                 |
|---------------------------|-------------------------|------------------|-------|---------------------------------|---------------------------------|---------------------------------|--|----------------------------------|---------------------------------------|
| HIGH-VOLTAGE WINDING (H)  | LOW-VOLTAGE WINDING (X) |                  |       | INTERNAL JUMPER                 | HIGH VOLTAGE WINDING            | LOW VOLTAGE WINDING             |  |                                  |                                       |
|                           |                         | Zyn11            | A     | H <sub>3</sub> - H <sub>2</sub> | H <sub>1</sub> - H <sub>3</sub> | X <sub>1</sub> - X <sub>3</sub> | $\frac{V_H \cdot \sqrt{3}}{V_X}$           | $\frac{V_H}{V_X \cdot \sqrt{3}}$ | NO ACCESSIBLE NEUTRAL ON HIGH WINDING |
|                           |                         |                  | B     | H <sub>1</sub> - H <sub>3</sub> | H <sub>2</sub> - H <sub>1</sub> | X <sub>2</sub> - X <sub>1</sub> |  |                                  |                                       |
|                           |                         |                  | C     | H <sub>2</sub> - H <sub>1</sub> | H <sub>3</sub> - H <sub>2</sub> | X <sub>3</sub> - X <sub>2</sub> |  |                                  |                                       |
|                           |                         | ZNyn1            | A     |                                 | H <sub>1</sub> - H <sub>0</sub> | X <sub>1</sub> - X <sub>2</sub> | $\frac{V_H}{V_X \cdot \sqrt{3}}$           | $\frac{V_H}{V_X \cdot \sqrt{3}}$ |                                       |
|                           |                         |                  | B     |                                 | H <sub>2</sub> - H <sub>0</sub> | X <sub>2</sub> - X <sub>3</sub> |  |                                  |                                       |
|                           |                         |                  | C     |                                 | H <sub>3</sub> - H <sub>0</sub> | X <sub>3</sub> - X <sub>1</sub> |  |                                  |                                       |
|                           |                         | ZNyn3            | A     |                                 | H <sub>1</sub> - H <sub>0</sub> | X <sub>3</sub> - X <sub>2</sub> | $\frac{V_H}{V_X \cdot \sqrt{3}}$           | $\frac{V_H}{V_X \cdot \sqrt{3}}$ |                                       |
|                           |                         |                  | B     |                                 | H <sub>2</sub> - H <sub>0</sub> | X <sub>1</sub> - X <sub>3</sub> |  |                                  |                                       |
|                           |                         |                  | C     |                                 | H <sub>3</sub> - H <sub>0</sub> | X <sub>2</sub> - X <sub>1</sub> |  |                                  |                                       |
|                           |                         | ZNyn5            | A     |                                 | H <sub>1</sub> - H <sub>0</sub> | X <sub>3</sub> - X <sub>1</sub> | $\frac{V_H}{V_X \cdot \sqrt{3}}$           | $\frac{V_H}{V_X \cdot \sqrt{3}}$ |                                       |
|                           |                         |                  | B     |                                 | H <sub>2</sub> - H <sub>0</sub> | X <sub>1</sub> - X <sub>2</sub> |  |                                  |                                       |
|                           |                         |                  | C     |                                 | H <sub>3</sub> - H <sub>0</sub> | X <sub>2</sub> - X <sub>3</sub> |  |                                  |                                       |
|                           |                         | ZNyn7            | A     |                                 | H <sub>1</sub> - H <sub>0</sub> | X <sub>2</sub> - X <sub>1</sub> | $\frac{V_H}{V_X \cdot \sqrt{3}}$           | $\frac{V_H}{V_X \cdot \sqrt{3}}$ |                                       |
|                           |                         |                  | B     |                                 | H <sub>2</sub> - H <sub>0</sub> | X <sub>3</sub> - X <sub>2</sub> |  |                                  |                                       |
|                           |                         |                  | C     |                                 | H <sub>3</sub> - H <sub>0</sub> | X <sub>1</sub> - X <sub>3</sub> |  |                                  |                                       |
|                           |                         | ZNyn9            | A     |                                 | H <sub>1</sub> - H <sub>0</sub> | X <sub>2</sub> - X <sub>3</sub> | $\frac{V_H}{V_X \cdot \sqrt{3}}$           | $\frac{V_H}{V_X \cdot \sqrt{3}}$ |                                       |
|                           |                         |                  | B     |                                 | H <sub>2</sub> - H <sub>0</sub> | X <sub>3</sub> - X <sub>1</sub> |  |                                  |                                       |
|                           |                         |                  | C     |                                 | H <sub>3</sub> - H <sub>0</sub> | X <sub>1</sub> - X <sub>2</sub> |  |                                  |                                       |
|                           |                         | ZNyn11           | A     |                                 | H <sub>1</sub> - H <sub>0</sub> | X <sub>1</sub> - X <sub>3</sub> | $\frac{V_H}{V_X \cdot \sqrt{3}}$           | $\frac{V_H}{V_X \cdot \sqrt{3}}$ |                                       |
|                           |                         |                  | B     |                                 | H <sub>2</sub> - H <sub>0</sub> | X <sub>2</sub> - X <sub>1</sub> |  |                                  |                                       |
|                           |                         |                  | C     |                                 | H <sub>3</sub> - H <sub>0</sub> | X <sub>3</sub> - X <sub>2</sub> |  |                                  |                                       |
|                           |                         | TT<br>0          | A     |                                 | H <sub>1</sub> - H <sub>2</sub> | X <sub>1</sub> - X <sub>2</sub> | $\frac{V_H}{V_X}$                          | $\frac{V_H}{V_X}$                |                                       |
|                           |                         |                  | B     | H <sub>1</sub> - H <sub>2</sub> | H <sub>1</sub> - H <sub>3</sub> | X <sub>1</sub> - X <sub>3</sub> |  |                                  |                                       |
|                           |                         |                  | C     | X <sub>1</sub> - X <sub>2</sub> |                                 |                                 |  |                                  |                                       |
|                           |                         | TT<br>30<br>LAG  | A     | H <sub>2</sub> - H <sub>3</sub> | H <sub>1</sub> - H <sub>3</sub> | X <sub>1</sub> - X <sub>2</sub> | $\frac{V_H}{V_X} \cdot \frac{\sqrt{3}}{2}$ | $\frac{V_H}{V_X}$                |                                       |
|                           |                         |                  | B     | X <sub>1</sub> - X <sub>2</sub> | H <sub>2</sub> - H <sub>3</sub> | X <sub>1</sub> - X <sub>3</sub> |  |                                  |                                       |
|                           |                         |                  | C     |                                 |                                 |                                 |  |                                  |                                       |
|                           |                         | TT<br>30<br>LEAD | A     | H <sub>2</sub> - H <sub>3</sub> | H <sub>1</sub> - H <sub>3</sub> | X <sub>1</sub> - X <sub>3</sub> | $\frac{V_H}{V_X} \cdot \frac{\sqrt{3}}{2}$ | $\frac{V_H}{V_X}$                |                                       |
|                           |                         |                  | B     | X <sub>1</sub> - X <sub>3</sub> | H <sub>2</sub> - H <sub>3</sub> | X <sub>2</sub> - X <sub>1</sub> |  |                                  |                                       |
|                           |                         |                  | C     |                                 |                                 |                                 |  |                                  |                                       |

NOTES:

651VANGUARD080308V13

- 1) Meas Ratio is the ratio measured by the instrument, where V<sub>H</sub>, V<sub>X</sub>, are the Nameplate Voltages.
- 2) Turns Ratio is the physical ratio of the number of turns on the core, expressed in terms of V<sub>H</sub> and V<sub>X</sub>.



**Vanguard Instruments  
Company, Inc.**

1520 S. Hellman Ave., Ontario, CA 91761, USA  
Phone: 909-923-9390 Fax: 909-923-9391  
[www.vanguard-instruments.com](http://www.vanguard-instruments.com)

