

## TEL-AL11-C2

CE

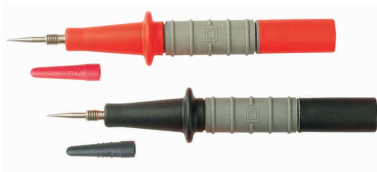

- 一組含紅黑各一支
- 探針：不鏽鋼，尖刺形，可旋接鱷魚夾
- 連接座：鍍鎳，適合4mm香蕉插頭連結
- 適合在量測體積細小，隙縫微小之物件，或刺穿保護層量測
- 可搭接所有SEW產製的4mm插頭測試線

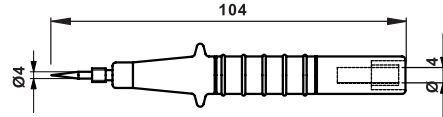

## TEL-AL11-C4

CE

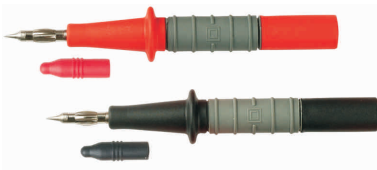

- 一組含紅黑各一支
- 探針：不鏽鋼，香蕉插頭，可搭接鱷魚夾
- 連接座：鍍鎳，適合4mm香蕉插頭連結
- 可搭接所有SEW產製的4mm插頭測試線

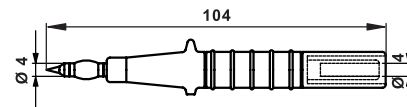

## AL11-CFP

NEW

CE



- 一組含紅黑各一支
- 探針為組合式設計，有護套，4mm香蕉套，因此具有4mm和2mm的功能。
- 內建保險絲保護
- 保險絲規格6 x 32mm
- 可搭接所有SEW產製的4mm插頭測試線
- 符合EN61010-031 with amendment AI：2008安規條款

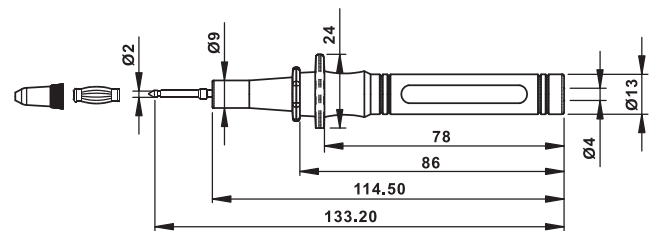

## AL11-CFPL

- 構造相同，保險絲規格不同：6 x 46mm

## 絕緣鑷形接頭



- 鑷形銅片接頭，用來連結端子，固定後方便量測
- 4mm的連接座，適合一般的4mm接頭
- 鑷形銅片凹口6.5mm，由大漸小，方便搭接使用

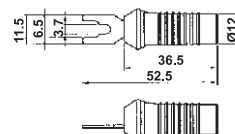

## AL11-C5F系列

**NEW**



CE

- 棒體材質：尼龍
- 探針外覆透明保護套，保護套管測時可自動縮入
- 探針可作2mm或4mm的設計製作
- 棒體內有保險絲保護設計
- 全長135mm
- 連接座適合4mm的插頭
- 符合歐洲安全規範：EN61010-031 CAT IV 600V 10A

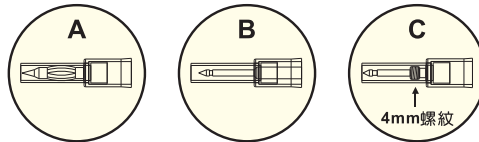
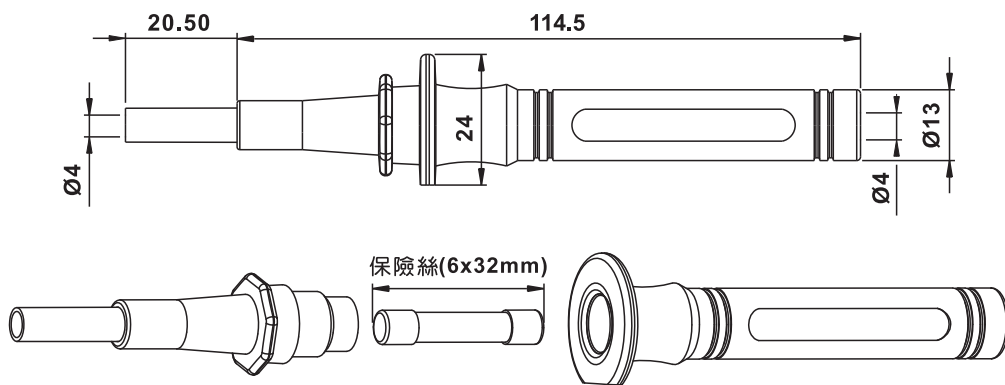

型 號	探針	保險絲規格
AL11-C5F4	A	6 x 32mm
AL11-C5F2	B	6 x 32mm
AL11-C5F2-4	C	6 x 32mm

## TEL-AL11-C2



- Red and Black each(set)
- Tip : Stainless Steel, sharp tip.
- Jack : Nickel Plated, 4mm banana Jack.
- The probe tip could screw into crocodile clips.
- Probes can be used with all SEW 4mm jack test leads.

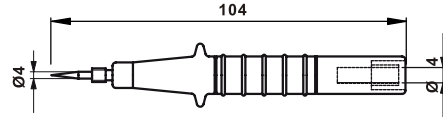

## TEL-AL11-C4



- Red and Black each(set)
- Tip : 4mm Stainless Steel caged banana probe tip.
- Jack : Nickel Plated, 4mm banana Jack.
- The probe tip could be used into non-screw crocodile clips.
- Probes can be used with all SEW 4mm jack test leads.

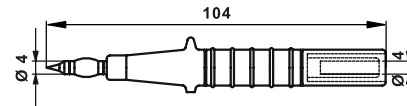

## AL11-CFP

**NEW**



- Red and Black each(set)
- Tip with protection caps.
- Lantern tip (removable) for use with sockets(4mm).
- Lantern tip can be removed for easy access to terminal blocks(2mm).
- Fuse protection available.
- Probes can be used with all sew 4mm jack test leads.
- Meets EN 61010-031 with amendment A1 : 2008
- Fuse size : 6 x 32mm

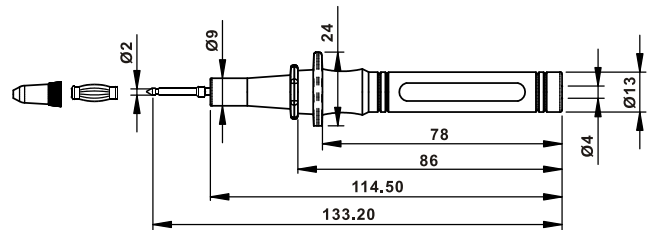

## AL11-CFPL

- Fuse size : 6 x 46mm

## Insulated Spade Lug



- Solid copper spade lug. Designed to fasten housing or screws for measurement.
- Fully insulated, axial mount 4mm banana jack.
- Designed especially for terminal posts,
- The Y-shaped tip accepts housings or screws that have a Diameter of 6.5mm or less.

